

MOTOR DRAWING

Premium Efficiency Motor: **OW30-9-364T**

WorldWide Electric Corporation

1 (800) 808-2131

Worldwideelectric.net

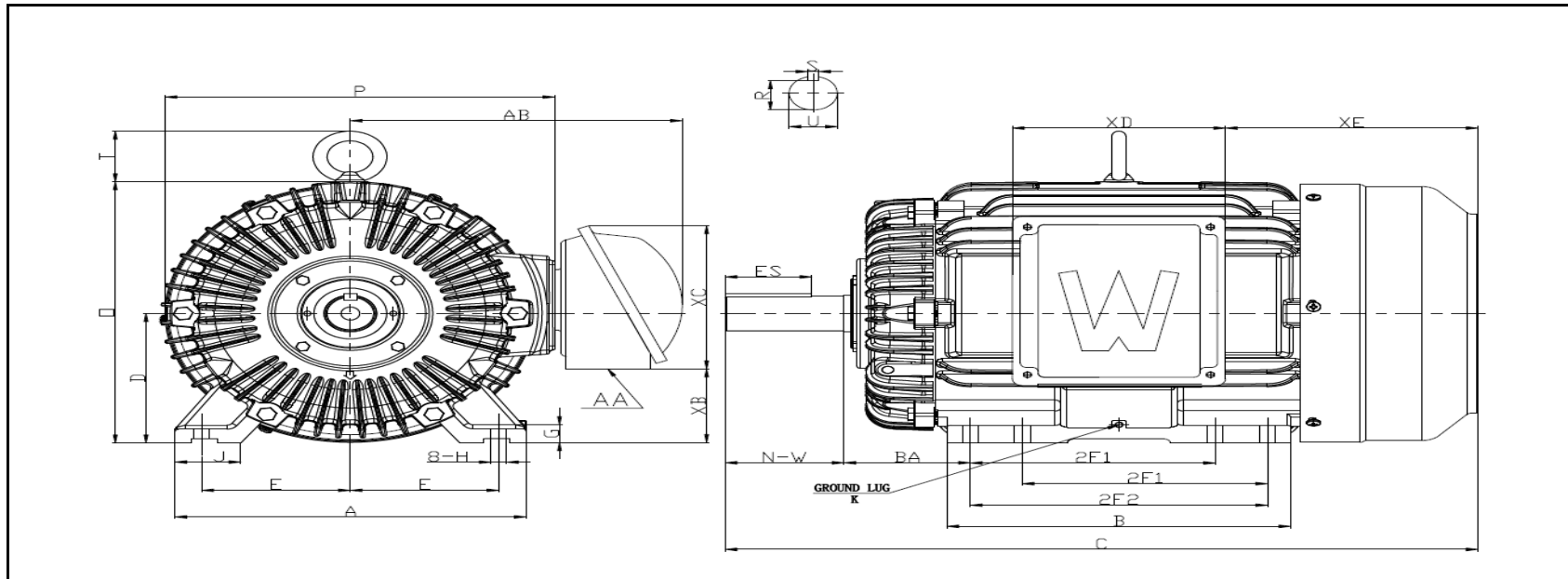

DIMENSION - INCHES

MOUNTING					A	B	C	D	G	J	P	O	T	AB
E	2F1	2F2	H	BA										
7	11.25	12.25	0.66	5.88	16.93	15.4	33.52	9	1.181	3.543	16.54	19.11	2.81	15.55

SHAFT & KEY					
S	ES	R	N-W	AH	U
0.625	4.28	2.021	5.88	N/A	2.375

TERMINAL BOX				
AA	XB	XC	XD	XE
3	4.29	11.27	9.17	12.4

GROUND LUG
K
M8