

MOTOR DRAWING

Premium Efficiency Motor: **OW75-9-445T**

WorldWide Electric Corporation

1 (800) 808-2131

Worldwideelectric.net

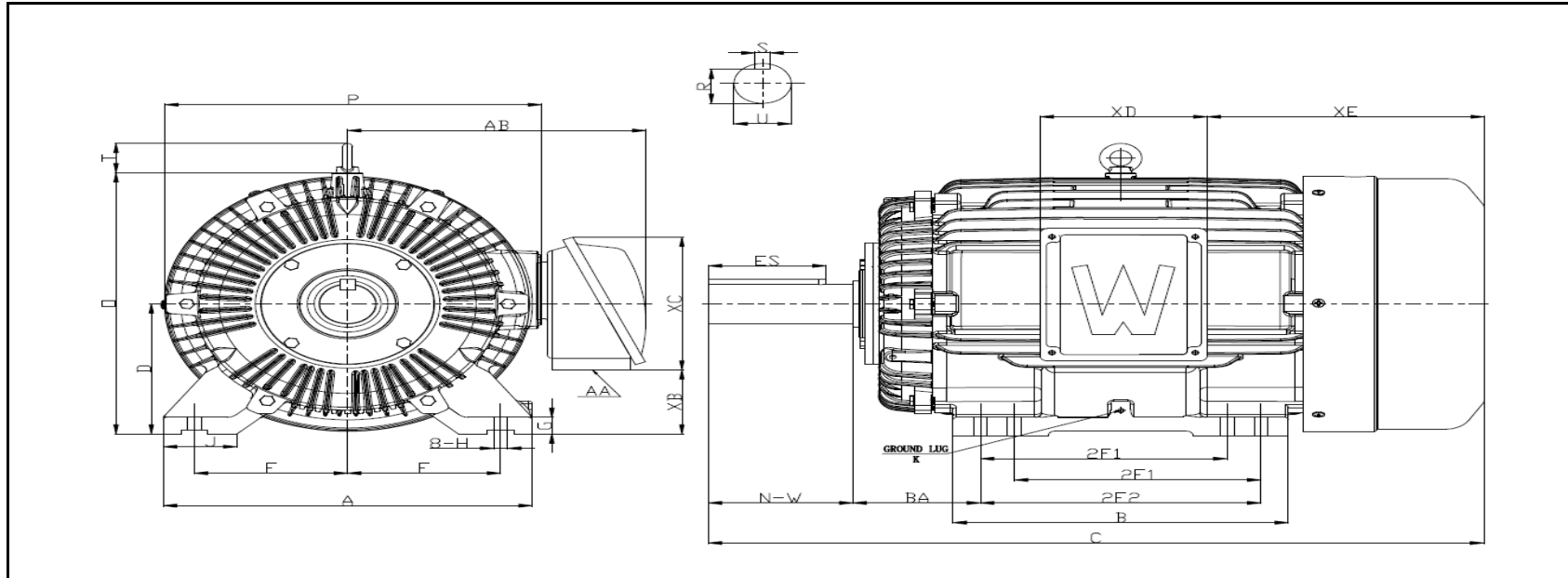

DIMENSION - INCHES

MOUNTING					A	B	C	D	G	J	P	O	T	AB
E	2F1	2F2	H	BA										
9	14.5	16.5	0.81	7.5	21.69	19.29	46.65	11	1.417	4.33	22.05	21.65	2.81	19.0985

SHAFT & KEY					
S	ES	R	N-W	AH	U
0.875	6.91	2.88	8.5	N/A	3.375

TERMINAL BOX				
AA	XB	XC	XD	XE
3	4.29	11.27	9.17	15.47

GROUND LUG
K
M8