

# MOTOR DRAWING

Premium Efficiency Motor: **OW25-9-326T**

WorldWide Electric Corporation

1 (800) 808-2131

Worldwideelectric.net

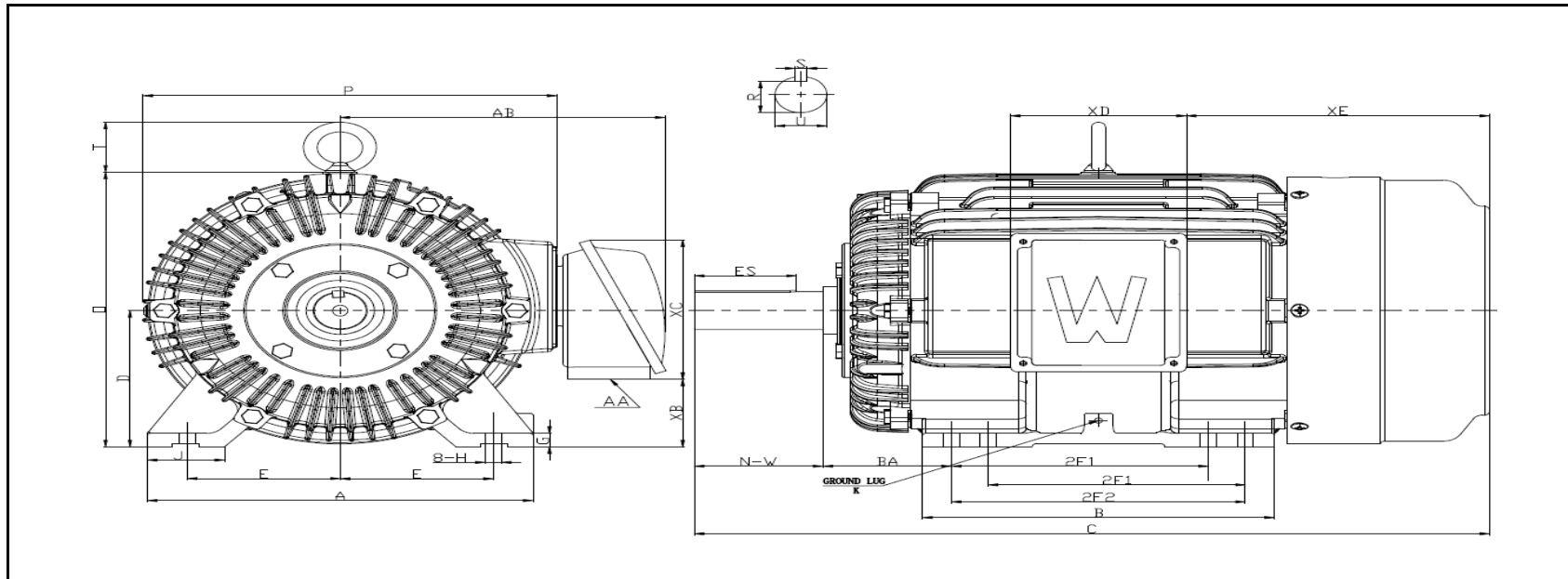

## DIMENSION - INCHES

MOUNTING					A	B	C	D	G	J	P	O	T	AB
E	2F1	2F2	H	BA										
6.25	10.5	12	0.66	5.25	15.75	14.37	32.67	8	0.984	3.15	16.3	16.13	2.42	12.8

SHAFT & KEY					
S	ES	R	N-W	AH	U
0.5	3.91	1.845	5.25	N/A	2.125

TERMINAL BOX				
AA	XB	XC	XD	XE
2	4.15	8.32	6.85	12.1

GROUND LUG
K
M8