

MOTOR DRAWING

Premium Efficiency Motor: **OW5-9-254T**

WorldWide Electric Corporation

1 (800) 808-2131

Worldwideelectric.net

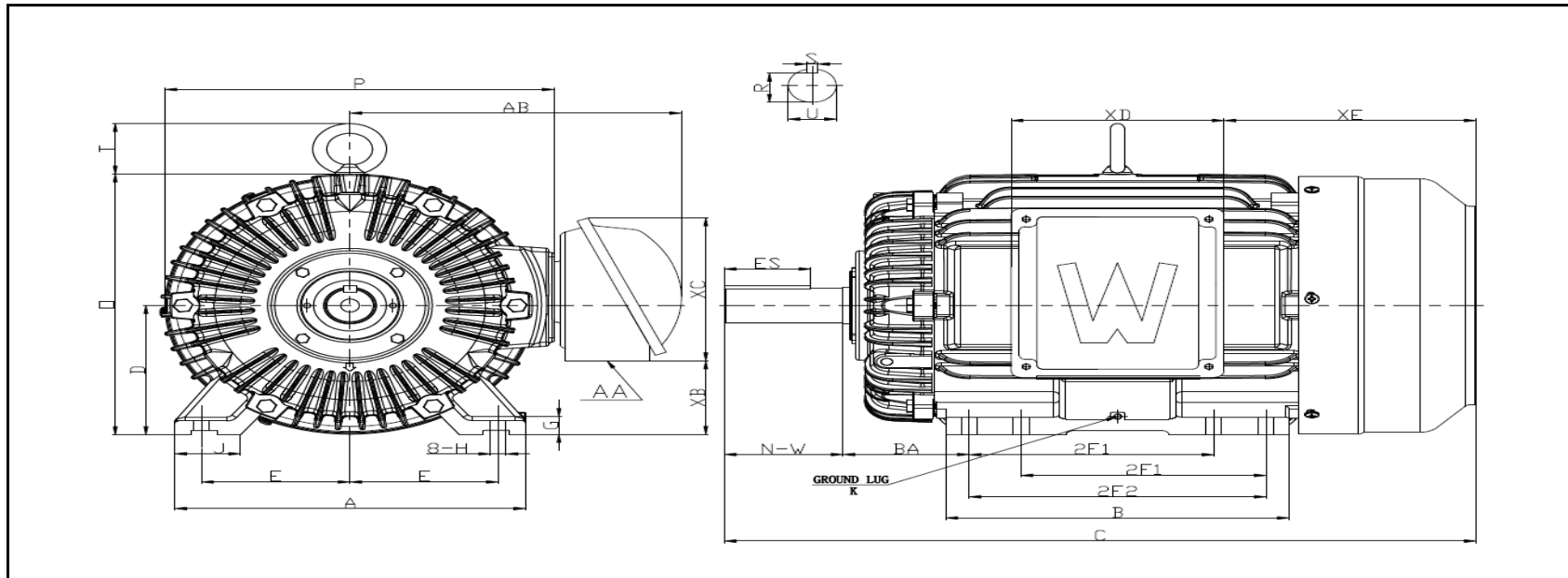

DIMENSION - INCHES

MOUNTING					A	B	C	D	G	J	P	O	T	AB
E	2F1	2F2	H	BA										
5	8.25	10	0.53	4.25	11.8	11.57	25.39	6.25	0.669	2.038	13.46	12.68	2.03	10.57

SHAFT & KEY					
S	ES	R	N-W	AH	U
0.375	2.91	1.416	4	N/A	1.625

TERMINAL BOX				
AA	XB	XC	XD	XE
1-1/2	2.86	7.2	5.8	8.1

GROUND LUG
K
M8