

MOTOR DRAWING

Premium Efficiency Motor: **OW10-9-284T**

WorldWide Electric Corporation

1 (800) 808-2131

Worldwideelectric.net

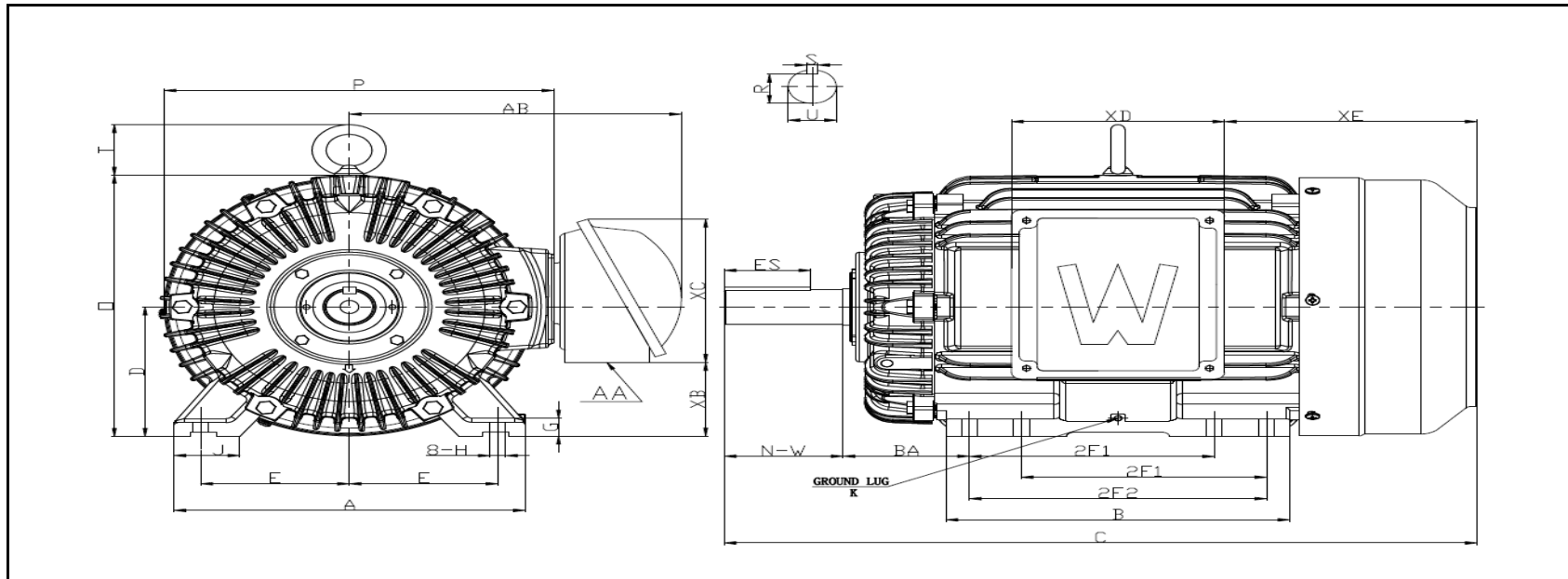

DIMENSION - INCHES

MOUNTING					A	B	C	D	G	J	P	O	T	AB
E	2F1	2F2	H	BA										
5.5	9.5	11	0.53	4.75	13.97	13.18	29.1	7	0.7795	3.07	14.56	14.04	2.42	12.02

SHAFT & KEY					
S	ES	R	N-W	AH	U
0.5	3.28	1.59	4.62	N/A	1.875

TERMINAL BOX				
AA	XB	XC	XD	XE
1-1/2	2.75	8.17	6.85	10.3

GROUND LUG
K
M8