

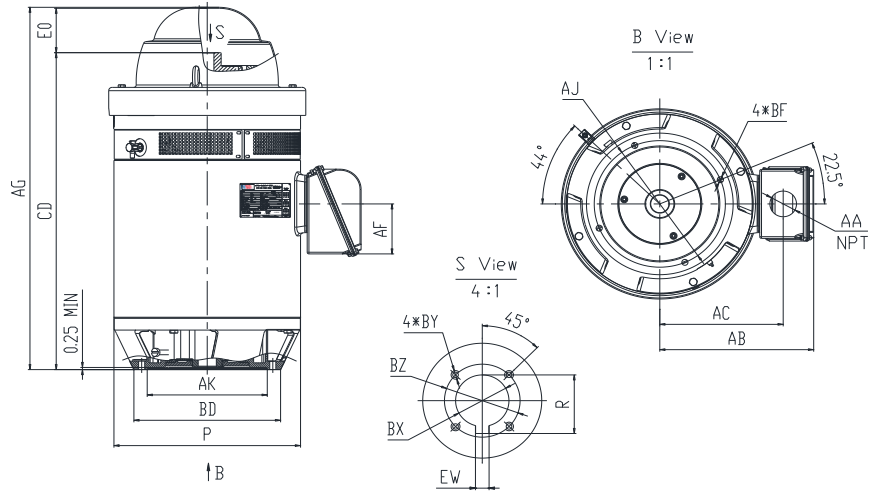

**V2-200S4-W44516A-EHT-19**

- VERTICAL HOLLOW SHAFT MOTOR
- NEMA PREMIUM EFFICIENCY
- INVERTER DUTY 20:1 VT
- INCLUDES INSULATED BEARING MOUNT - 40 HP AND ABOVE
- EXTRA HIGH THRUST DESIGN
- THREE PHASE, OPEN DRIP PROOF (WP1) ENCLOSURE
- NON-REVERSE BALL TYPE RATCHET
- COUPLING INCLUDED



**DIMENSIONS**

HP	RPM	Frame	MOUNTING DIMENSIONS													
			BD	AJ	AK	BF	BX	BZ	EW	R	BY	CD	E0 >	AC	AA	AF
200	1788	445TP	16.5	14.75	13.5	0.69	1-11/16	2.5	0.375	1.854	1/4-20	44.78	5.4	16.18	3	7.56

OVERALL DIMENSIONS			BEARINGS	
P	AB	AG	UPPER	LOWER
23.3	20.7	50.29	7232B/DT	6318

**COUPLING:** Motor comes with a 1.69" coupling. You may select a different size coupling at no extra charge.

**BEARING LUBRICATION:** The lower bearing comes lubricated with Mobil Polyrex EM Polyurea Grease.

**OIL RESERVOIR:** Motor is shipped without oil. The oil capacity is 5.61 quarts.

**STEADY BUSHING:** Motor is designed to accept a steady bushing. The bore size is 1-11/16 inches.





## V2-200S4-W44516A-EHT-19





**VERTICAL HOLLOW SHAFT MOTOR**  
**NEMA PREMIUM EFFICIENCY**  
**INVERTER DUTY 20:1 VT**  
**INCLUDES INSULATED BEARING MOUNT - 40 HP AND ABOVE**  
**EXTRA HIGH THRUST DESIGN**  
**THREE PHASE, OPEN DRIP PROOF (WP1) ENCLOSURE**  
**NON-REVERSE BALL TYPE RATCHET**  
**COUPLING INCLUDED**

### PERFORMANCE DATA

HP	RPM	Frame	Voltage	Frequency (Hz)	Full Load S.F.	Insulation Class	NEMA Design	Slip (%)	NEMA Code	Enclosure Type	IP Rating	Max. Ambient	Rating CONT
200	1788	445TP	460	60	1.15	F	B	0.66	G	WP1	23	40° C	S1

Amps (460V)		Efficiency (%)				Power Factor			Torque (ft-lb)			Down Thrust (lbs.)	Angular Contact Bearing	Radial Ball Bearing	Connection	Weight (lbs.)
FLA	LRA	100%	75%	50%	Min.	100%	75%	50%	FLT	LRT %	BDT %	19000	UPPER	LOWER	6 Lead Δ	2099
221	1462	95.8	94.8	93.7	95.0	0.88	0.88	0.83	584	166	220		7232B/DT	6318		

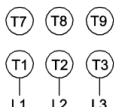
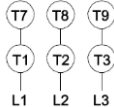
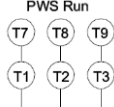
### NAME PLATE

 <b>VERTICAL HOLLOW SHAFT EXTRA HIGH THRUST DESIGN</b> 										CONNECTION DIAGRAMS	
MODEL V2-200S4-W44516A-EHT-19					FRAME 445TP					<b>PWS Start</b> 	
Hz	60	S.F.	1.15	ENCL	WP1	DESIGN	B				
HP	200	RPM	1788	INS	F	PHASE	3			<b>Across The Line</b> 	
VOLTS	460	FLA	221	MAX.AMBIENT			40° C				
Enclosure	ODP	IP	23	RATING			CONTINUOUS		<b>PWS Run</b> 		
NEMA CODE	G	P.F.	0.88	MOTOR WEIGHT			2099 LBS.				
NOM EFF	95.8	MIN EFF	95.0	CONNECTION			6 Lead Δ		<b>PART WIND START CAPABLE @ 460V</b>		
DOWN THRUST		19000 LBS.		BASE DIAMETER		16.5 INCHES					
UPPER BEARING		7232B/DT (X 2) EHT		LOWER BEARING		6318					
OIL CAP. UPPER BEARING		5.61 QTS.		LUBRICATION		MOBIL POLYREX EM					
NON-REVERSE RATCHET - BALL TYPE				SERIAL NO.							
Specifically designed for use on deep well turbine pump applications. Hernando, Mississippi				 <b>CC082A</b> E310089							
										ROTATION	
<b>MOTOR IS SUITABLE FOR INVERTER RATED 20:1 VT</b>											

### APPLICATIONS:

Specifically designed for use on deep well turbine pump applications. The coupling is equipped with a non-reverse ratchet, which prevents motor rotation from backspin at shutdown. These motors are built to NEMA standards and have special bearing arrangements to carry heavy thrust loads.