

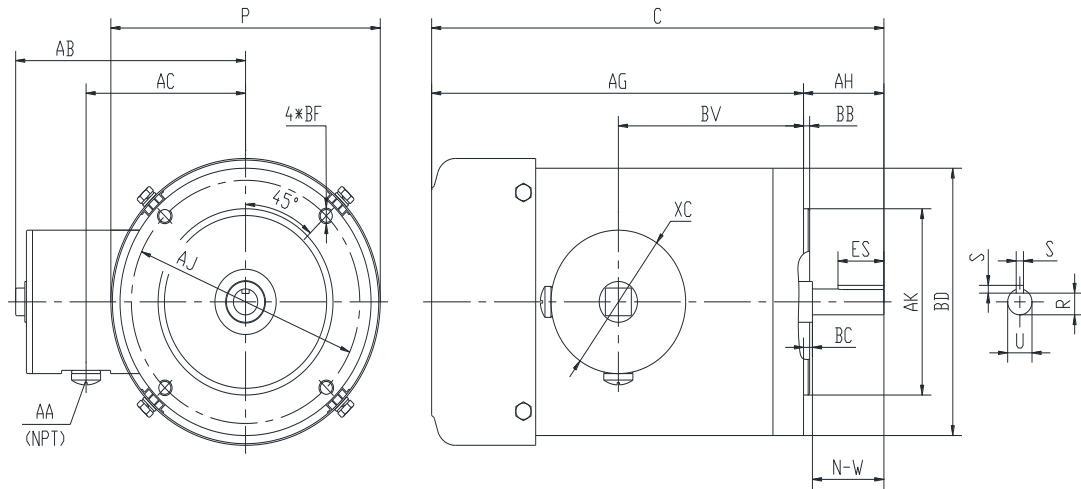

SS56C1/2M-2-RB-A

WASHDOWN DUTY MOTOR
HIGH EFFICIENCY / EISA COMPLIANT
STAINLESS STEEL CONSTRUCTION - ROUND BODY (C-FLANGE FOOTLESS)
TOTALLY ENCLOSED FAN COOLED - IP66 CONSTRUCTION
INVERTER DUTY 10:1 CT; 20:1 VT - NEMA MG1 PART 31



DIMENSIONS

HP	RPM	Frame	MOUNTING			FLANGE						
			C	P	AG	AH	AJ	AK	BB	BC	BD	BF
1/2	3600	56C	11.59	6.95	9.53	2.06	5.875	4.5	0.16	-0.19	6.5	4*3/8-16

Shaft Extension, Key Set					Conduit Box				
U	R	S	ES	N-W	AA	AB	AC	BV	XC
0.625	0.517	0.188	1.41	1.88	0.5	5.95	4.5	4.75	3.45

Bearings		Mount
DE	ODE	
6205-2RS	6205-2RS	F1

BEARING LUBRICATION: The bearings come lubricated with Mobil Polyrex EM Polyurea Grease.





SS56C1/2M-2-RB-A

WASHDOWN DUTY MOTOR
HIGH EFFICIENCY / EISA COMPLIANT
STAINLESS STEEL CONSTRUCTION - ROUND BODY (C-FLANGE FOOTLESS)
TOTALLY ENCLOSED FAN COOLED - IP66 CONSTRUCTION
INVERTER DUTY 10:1 CT; 20:1 VT - NEMA MG1 PART 31

PERFORMANCE DATA

HP	RPM	Frame	Voltage	Frequency (Hz)	Full Load S.F.	Insulation Class	NEMA Design	Slip (%)	NEMA Code	Enclosure Type	IP Rating	Max. Ambient
1/2	3460	56C	230/460	60	1.15	F	B	3.9	K	TEFC	66	40 °C

Amps (460V)		Efficiency (%)			Power Factor			Torque (ft-lb)			DE Bearing	ODE Bearing	Connection	Weight (lbs.)
FLA	LRA	100%	75%	50%	100%	75%	50%	FLT	LRT %	BDT %				
0.75	10	77.0	75.0	67.0	0.88	0.67	0.58	0.7	285	300	6205-2RS	6205-2RS	9 Lead 2Y/Y	29

*Usable at 208 Volts

NAME PLATE

		THREE PHASE AC INDUCTION MOTOR INVERTER DUTY 20:1 VT; 10:1 CT						Hernando, MS 38632				
Model :		SS56C1/2M-2-RB-A				IP	66	FRAME	56C	LB/WT	29	
HZ	60	S.F.	1.15	HZ	50	S.F.	1.0	NEMA DESIGN		B		
HP	1/2	RPM	3460	HP	1/2	RPM	2855	ENCL.	TEFC	INS	F	
VOLTS		230/460		VOLTS		190/380		DUTY	CONT	AMB	40 °C	
AMPS		1.5/0.75		AMPS		1.8/0.9		DE BRG		6205-2RS		
CODE	K	P.F.	0.88	CODE	K	P.F.	0.90	ODE BRG		6205-2RS		
EFF	77.0	MIN	74.0	EFF	74.0	MIN	71.0	SER NO.				
								CC082A		MADE IN CHINA		

Factory Certified for T2B
 Div 2. Class I, Gr. A , B , C & D
 and Class II, Gr. F & G

APPLICATIONS:

Applications include washdown applications, food processing, chemical processing, pharmaceuticals, poultry processing, meat processing, dairy applications, bakeries, snack foods, bottling and extremely corrosive environments.