

SS56C3/4M-6-A

WASHDOWN DUTY MOTOR
HIGH EFFICIENCY / EISA COMPLIANT
STAINLESS STEEL CONSTRUCTION - C-FLANGE WITH FEET
TOTALLY ENCLOSED FAN COOLED - IP66 CONSTRUCTION
INVERTER DUTY 10:1 CT; 20:1 VT - NEMA MG1 PART 31

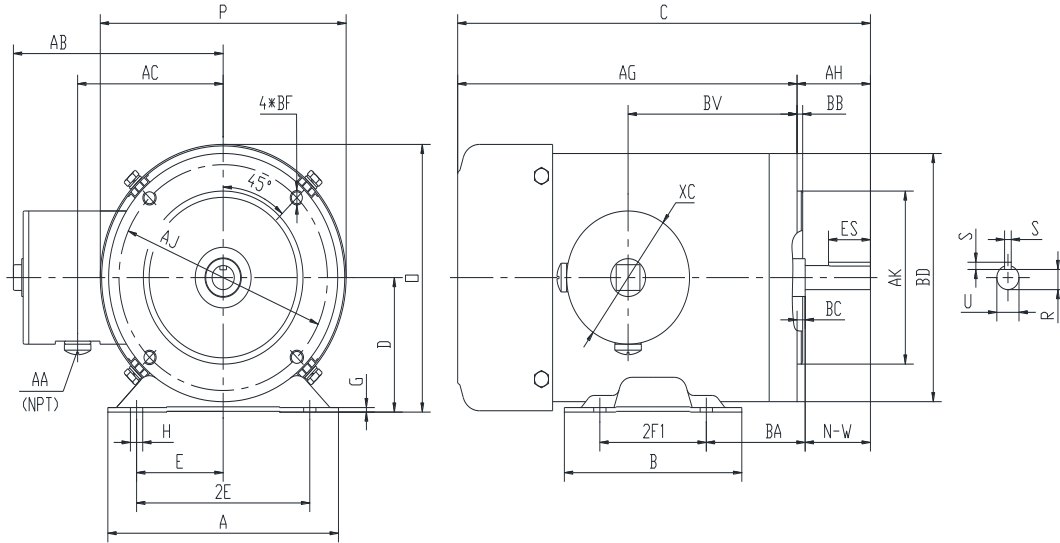

DIMENSIONS

HP	RPM	Frame	MOUNTING													
			A	B	C	D	G	H	E	2E	2F1	2F2	O	P	AG	BA
3/4	1200	56C	6.5	5	12.57	3.5	0.118	1.22*0.34	2.44	4.88	3	NA	6.98	6.95	10.51	2.75

FLANGE							Shaft Extension, Key Set				
AH	AJ	AK	BB	BC	BD	BF	U	R	S	ES	N-W
2.06	5.875	4.5	0.16	-0.19	6.5	4*3/8-16	0.625	0.517	0.188	1.41	1.88

Conduit Box					Bearings		Mount
AA	AB	AC	BV	XC	DE	ODE	
0.5	5.95	4.5	5.75	3.45	6205-2RS	6205-2RS	F1

BEARING LUBRICATION: The bearings come lubricated with Mobil Polyrex EM Polyurea Grease.



SS56C3/4M-6-A

WASHDOWN DUTY MOTOR
HIGH EFFICIENCY / EISA COMPLIANT
STAINLESS STEEL CONSTRUCTION - C-FLANGE WITH FEET
TOTALLY ENCLOSED FAN COOLED - IP66 CONSTRUCTION
INVERTER DUTY 10:1 CT; 20:1 VT - NEMA MG1 PART 31

PERFORMANCE DATA

HP	RPM	Frame	Voltage	Frequency (Hz)	Full Load S.F.	Insulation Class	NEMA Design	Slip (%)	NEMA Code	Enclosure Type	IP Rating	Max. Ambient
3/4	1155	56C	230/460	60	1.15	F	B	3.8	K	TEFC	66	40 °C

Amps (460V)		Efficiency (%)			Power Factor			Torque (ft-lb)			DE Bearing	ODE Bearing	Connection	Weight (lbs.)
FLA	LRA	100%	75%	50%	100%	75%	50%	FLT	LRT %	BDT %				
1.85	12.5	80.0	76.0	71.0	0.65	0.58	0.50	3.3	255	280	6205-2RS	6205-2RS	9 Lead 2Y/Y	34

*Usable at 208 Volts

NAME PLATE

Model :		SS56C3/4M-6-A				IP	66	FRAME	56C	LB/WT	34
HZ	60	S.F.	1.15	HZ	50	S.F.	1.0	NEMA DESIGN	B		
HP	3/4	RPM	1155	HP	3/4	RPM	955	ENCL.	TEFC	INS	F
VOLTS	230/460		VOLTS	190/380		DUTY	CONT	AMB	40 °C		
AMPS	2.8/1.4		AMPS	3.4/1.7		DE BRG	6205-2RS				
CODE	K	P.F.	0.65	CODE	K	P.F.	0.67	ODE BRG	6205-2RS		
EFF	80.0	MIN	77.0	EFF	77.0	MIN	74.0	SER NO.			
								CC082A		MADE IN CHINA	

Factory Certified for T2B
 Div 2. Class I, Gr. A , B , C & D
 and Class II, Gr. F & G

APPLICATIONS:

Applications include washdown applications, food processing, chemical processing, pharmaceuticals, poultry processing, meat processing, dairy applications, bakeries, snack foods, bottling and extremely corrosive environments.