



WORLDWIDE MOTOR CONTROLS
Soft Starters
Positive Displacement Pump Soft Starters

WWEPDASSRV12-30

General Product Specifications

- NEMA 4/12 Enclosure
- Service entrance rated
- 230/460V Rated
- Advanced Motor Protection
- Full panel fused surge protection
- CB with door mounted lockable handle
- Integral full rated bypass contactor with X-Line mode
- Accepts inputs for up to 7 Murphy switches
- Individually selectable for NO or NC
- Interposing relays isolation on Murphy inputs
- Vibration tip, crank case oil level, low pressure, high pressure, oil level, lubricator oil level, spare lamps
- Front panel indicators and keypad
- Start/stop, HOA, reset buttons
- Indicating LED's on I/O board (troubleshooting aid)
- Current imbalance, overcurrent, undercurrent, phase loss, shorted load, and ground fault protections standard

Rated Power	230V	15 HP
	460V	30 HP
Max Full Load Amps		45 A
Outside Dimensions		37x15x12
Input Voltage	230/460VAC \pm 10%, 50/60Hz Optional 380, 415, 575VAC	
Overload Rating	Normal Duty: 500% for 20s (Variable Torque Applications) Heavy Duty: 500% for 60s (Constant Torque Applications)	
Overload Range	40-60 A	
CT Rating	50:5	
Ambient Conditions	0° to 50 °C, 5-95% relative humidity, 0-3300ft above sea level (Can be designed to operate outside these conditions)	
Inputs	7	dry contacts using 24VDC
Programmable Outputs	3	2-Form C (5A, 240VAC max) 1- Form A 26 programmable functions
Dedicated Fault Output	1	AC Triac solid state switch 240VAC 50mA max

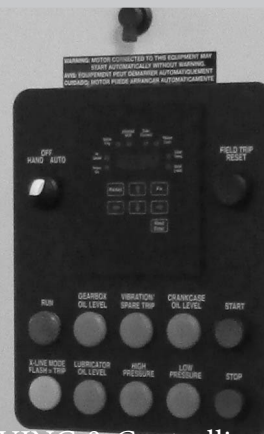

DRIVING & Controlling

WorldWideElectric

Industry



REV NO	REVISION	DATE	BY
1	RELEASED	03/13/08	CL
2	UPDATED	06/15/15	GC

WWEPDASSRV12-30

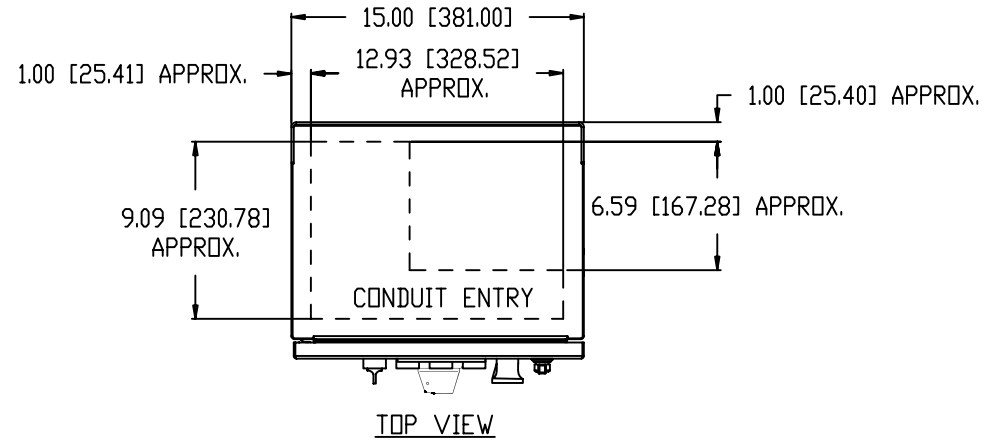

TOP VIEW

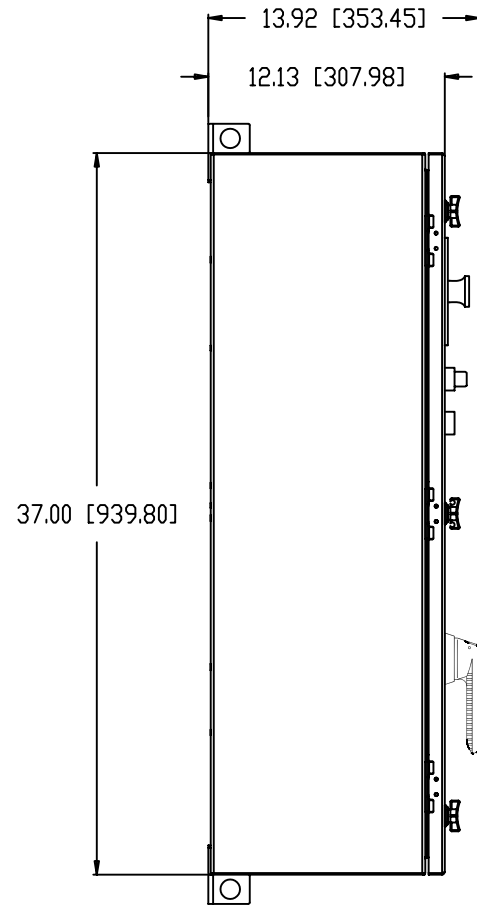

LEFT SIDE VIEW

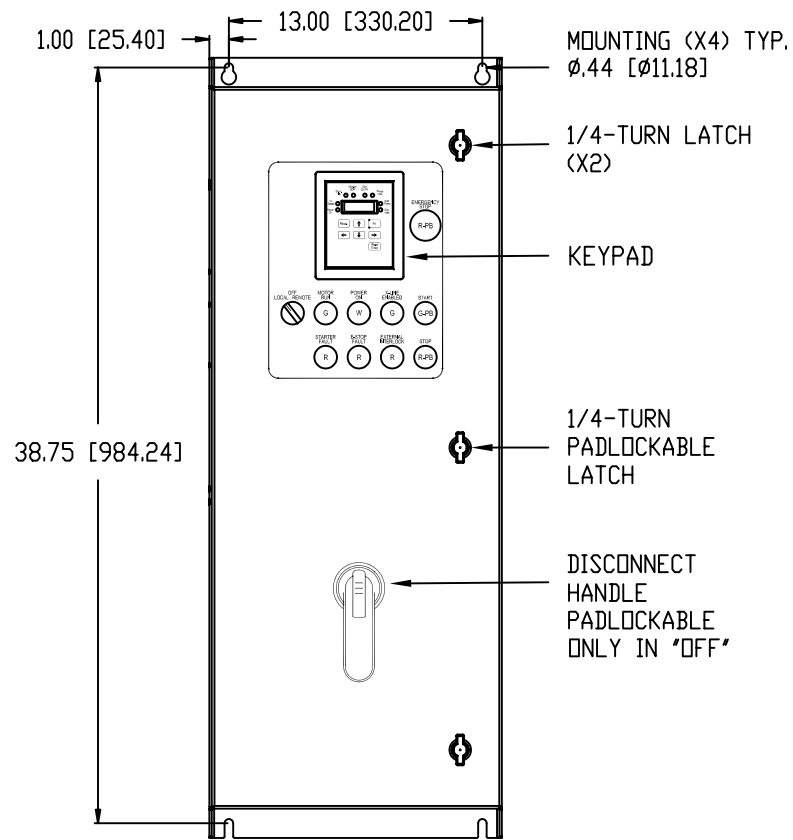

FRONT VIEW

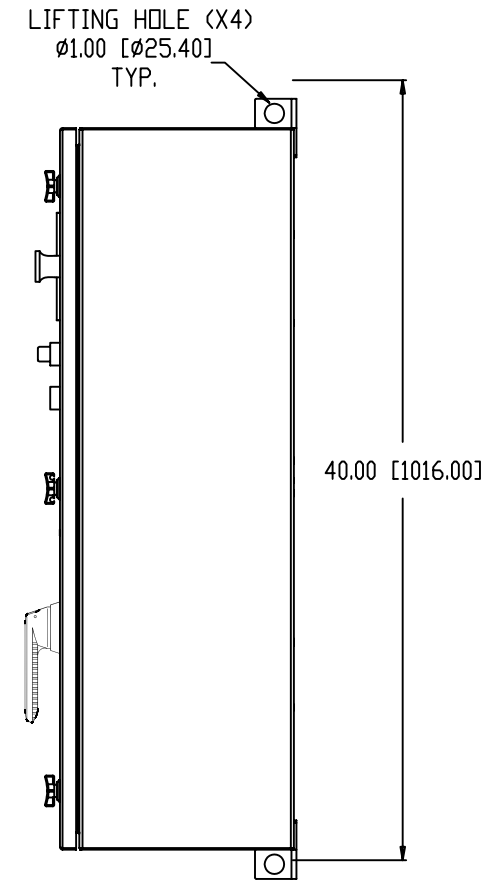

RIGHT SIDE VIEW

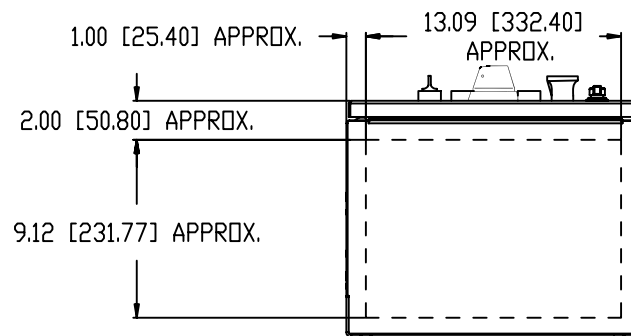

BOTTOM VIEW

TYPE: NEMA TYPE 4/12
 COLOR: WHITE POWDER COAT
 MATERIAL: 14 GA. [1.90MM] CRS
 APPROXIMATE WEIGHT: 115 LBS. [55 KG]
 DIMENSIONS: INCHES [MILLIMETERS]

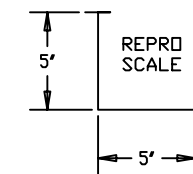

		800.808.2131 3540 WINTON PLACE ROCHESTER, NY 14623	
SIZE 1 ENCLOSURE WITH DISCONNECT OUTLINE DIMENSION			
SCALE	DRAWING NUMBER	DRAWN BY	REV. BY
NOTED	94-0291	RRH	GFC
		CHK'D. BY	
SHEET	REV. No.	DATE	
1 OF 1	2	06/15/2015	