



WORLDWIDE MOTOR CONTROLS
Soft Starters
Positive Displacement Pump Soft Starters

WWEPDASSRV12-600

General Product Specifications

- NEMA 4/12 Enclosure
- Service entrance rated
- 230/460V Rated
- Advanced Motor Protection
- Full panel surge protection
- CB with door mounted lockable handle
- Integral full rated bypass contactor with X-Line mode
- Accepts inputs for up to 7 Murphy switches
- Individually selectable for NO or NC
- Interposing relays isolation on Murphy inputs
- Vibration tip, crank case oil level, low pressure, high pressure, oil level, lubricator oil level, spare lamps
- Front panel indicators and keypad
- Start/stop, HOA, reset buttons
- Indicating LED's on I/O board (troubleshooting aid)
- Current imbalance, overcurrent, undercurrent, phase loss, shorted load, and ground fault protections standard

Rated Power	230V	300 HP
	460V	600 HP
Max Full Load Amps		800 A
Outside Dimensions		92x36x30
Input Voltage	230/460VAC \pm 10%, 50/60Hz Optional 380, 415, 575VAC	
Overload Rating	Normal Duty: 500% for 20s (Variable Torque Applications) Heavy Duty: 500% for 60s (Constant Torque Applications)	
Overload Range	560-840 A	
CT Rating	700:5	
Ambient Conditions	0° to 50 °C, 5-95% relative humidity, 0-3300ft above sea level (Can be designed to operate outside these conditions)	
Inputs	7	dry contacts using 24VDC
Programmable Outputs	3	2-Form C (5A, 240VAC max) 1- Form A 26 programmable functions
Dedicated Fault Output	1	AC Triac solid state switch 240VAC 50mA max

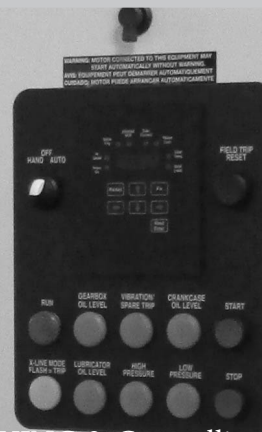

DRIVING & Controlling

WorldWideElectric

Industry



WWEPDASSRV12-600

REV NO	REVISION	DATE	BY
1	RELEASED	03/20/08	RD
2	UPDATED	06/16/15	GC

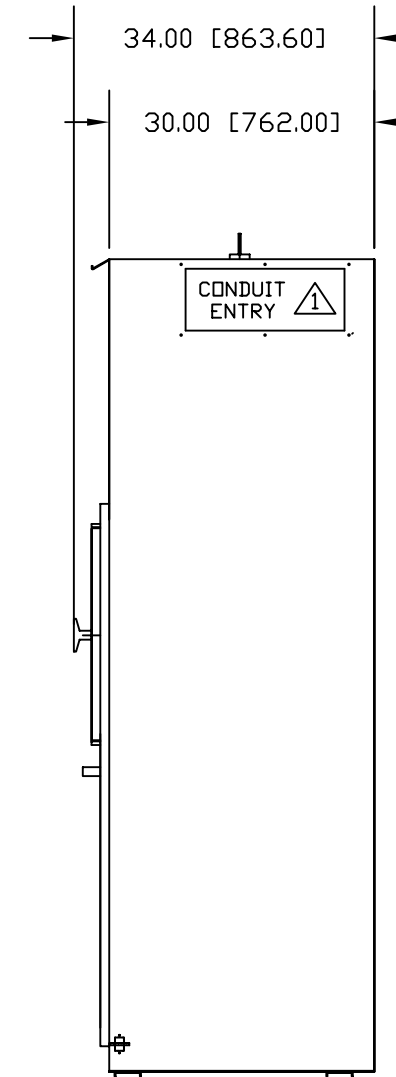
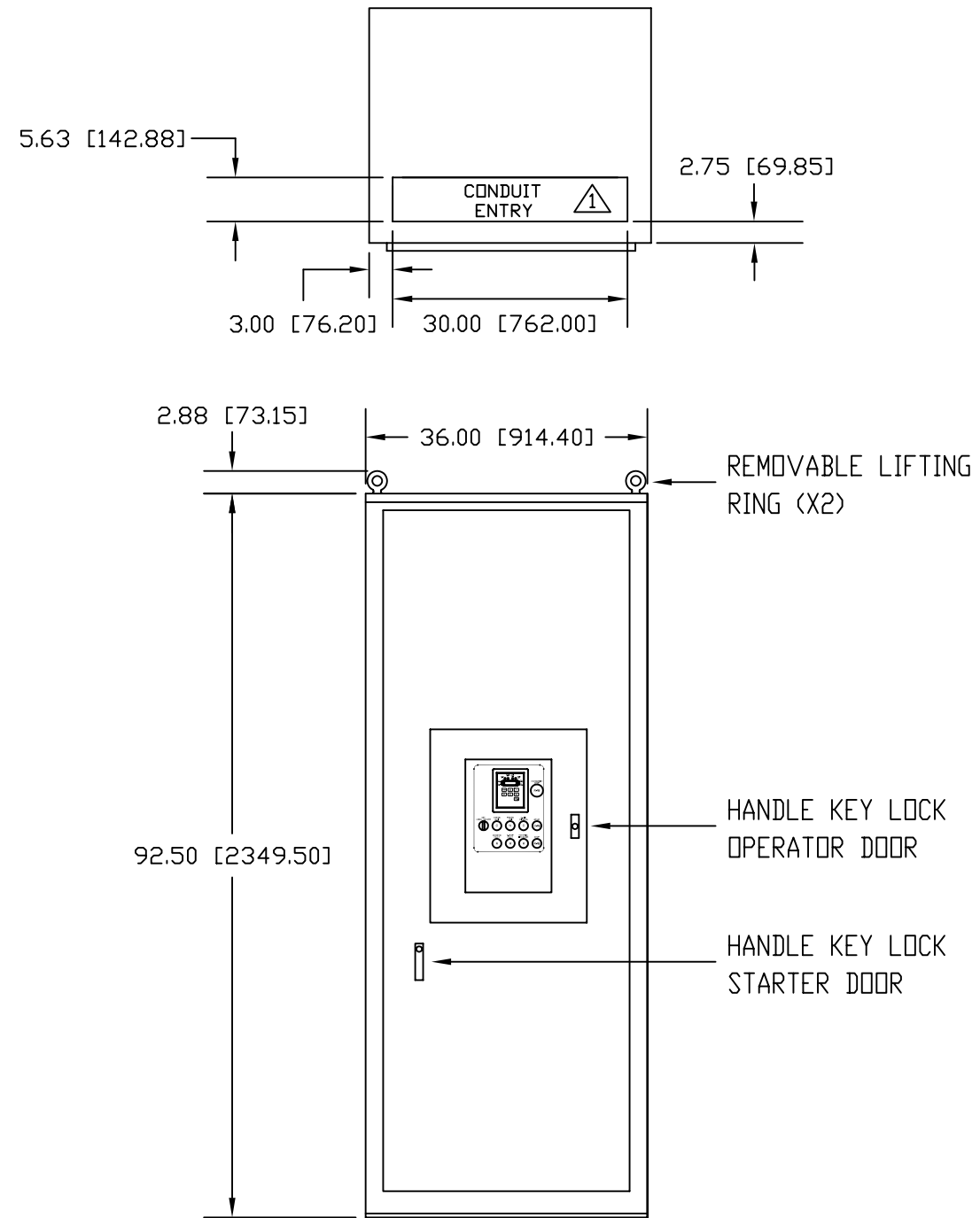
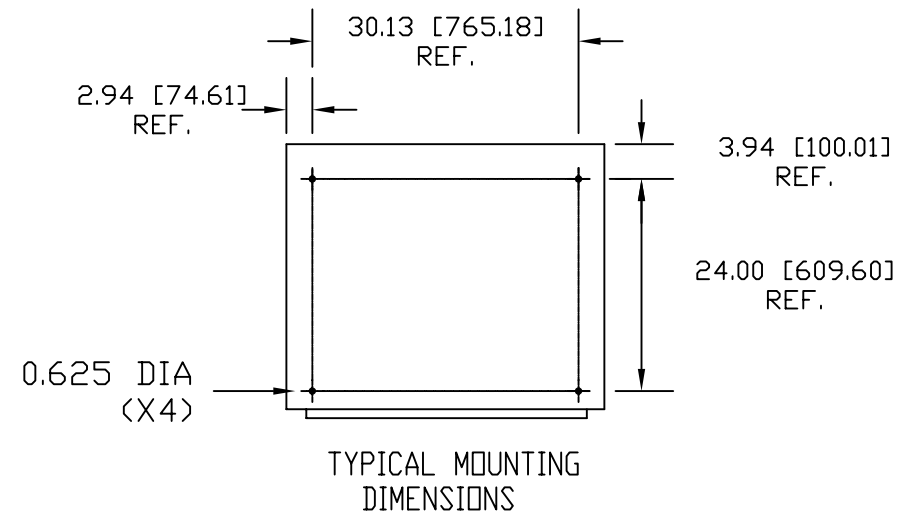

⚠
 CONDUIT ENTRY TOP, BOTTOM, AND BOTH TOP SIDES ARE COVERED BY REMOVABLE GASKETED PLATES

TYPE: NEMA TYPE 12
 FINISH: ANSI 61 GRAY
 MATERIAL: 11 GA. [2.95MM] CRS
 APPROXIMATE WEIGHT: 1200 LBS. [544 KG]
 DIMENSIONS: INCHES [MILLIMETERS]

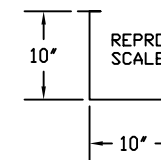
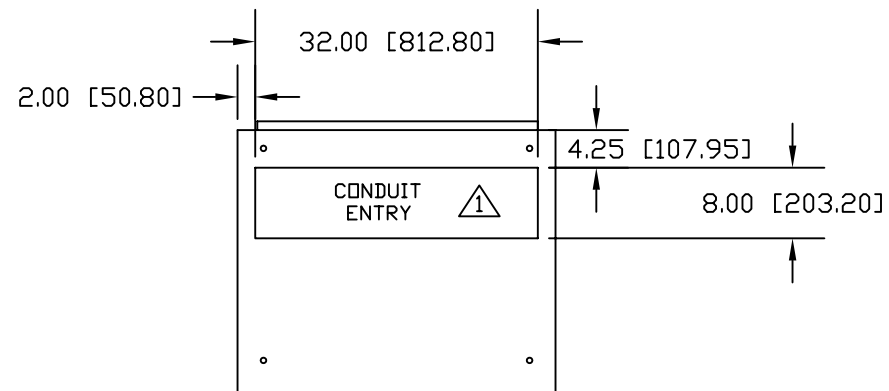

		800.808.2131 3540 WINTON PLACE ROCHESTER, NY 14623	
SIZE 3 ENCLOSURE OUTLINE DIMENSION			
SCALE	DRAWING NUMBER	DRAWN BY	REV. BY
NOTED	94-0297	RRH	GFC
	CHK'D. BY		
SHEET	REV. No.	DATE	
1 OF 1	2	06/16/2015	