

WORLDWIDE ELECTRIC CORPORATION
HdR SERIES PROGRAM - WORM GEAR SPEED REDUCERS
FLANGE INPUT - HOLLOW BORE OUTPUT - DIMENSIONS

MODEL # HdRF262-* -H-182TC

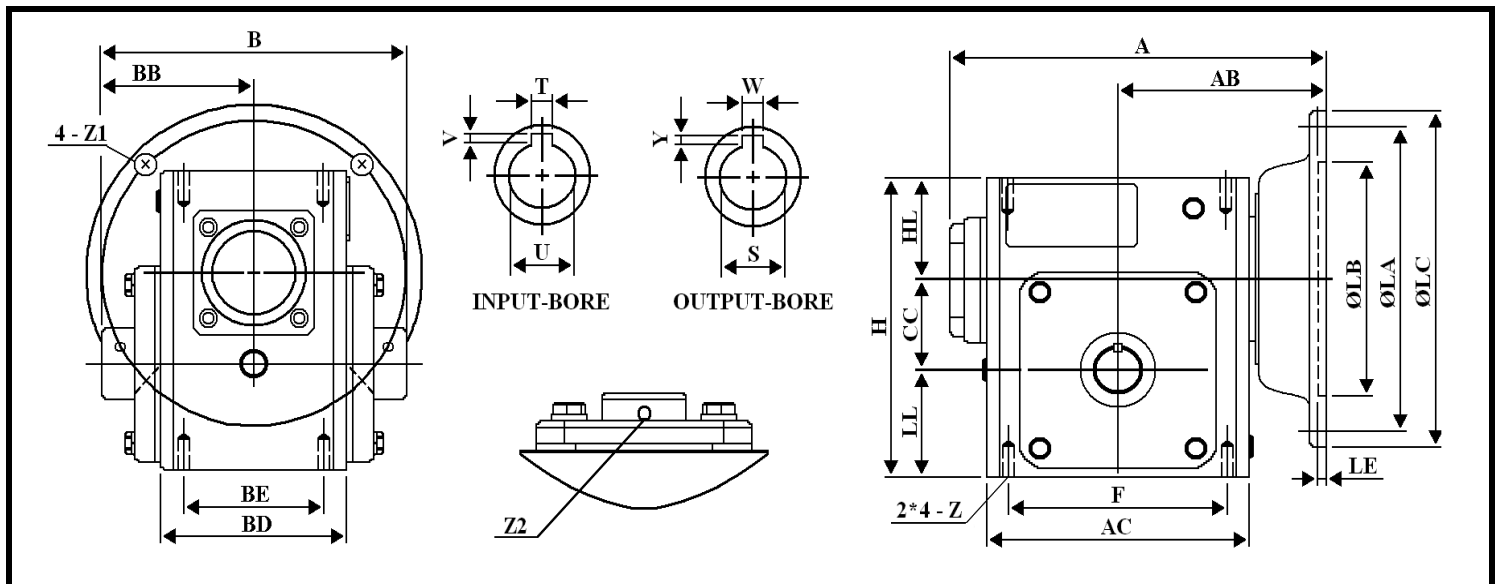
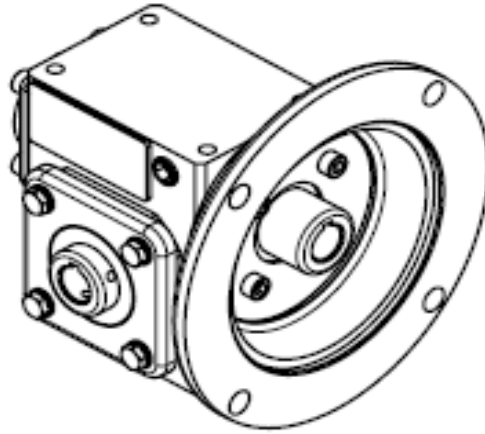

DIMENSIONS - Inches

Size	A	AB	AC	B	BB	BD	BE	CC	F	H	HL	LL	Z2	Z
262	10.59	6.24	7.165	7	3.5	4.68	3.375	2.625	6.38	8	2.437	2.938	1/4-28 UNF*7/16	3/8-16 UNC

Size	INPUT BORE		OUTPUT BORE		FLANGE					NEMA FRAME	OIL (OZ.)
	U	T*V	S	W*Y	LA	LB	LC	LE	Z1		
262	1.125	1/4 * 1/8	1.437	3/8 * 3/16	8.5	7.25	9	0.2	0.551	182TC	34.55

* Suitable For Any Ratio

