

# WORLDWIDE ELECTRIC CORPORATION

## HdR SERIES PROGRAM - WORM GEAR SPEED REDUCERS

### FLANGE INPUT - HOLLOW BORE OUTPUT - DIMENSIONS

**MODEL # HdRF262-\*-H-56C**

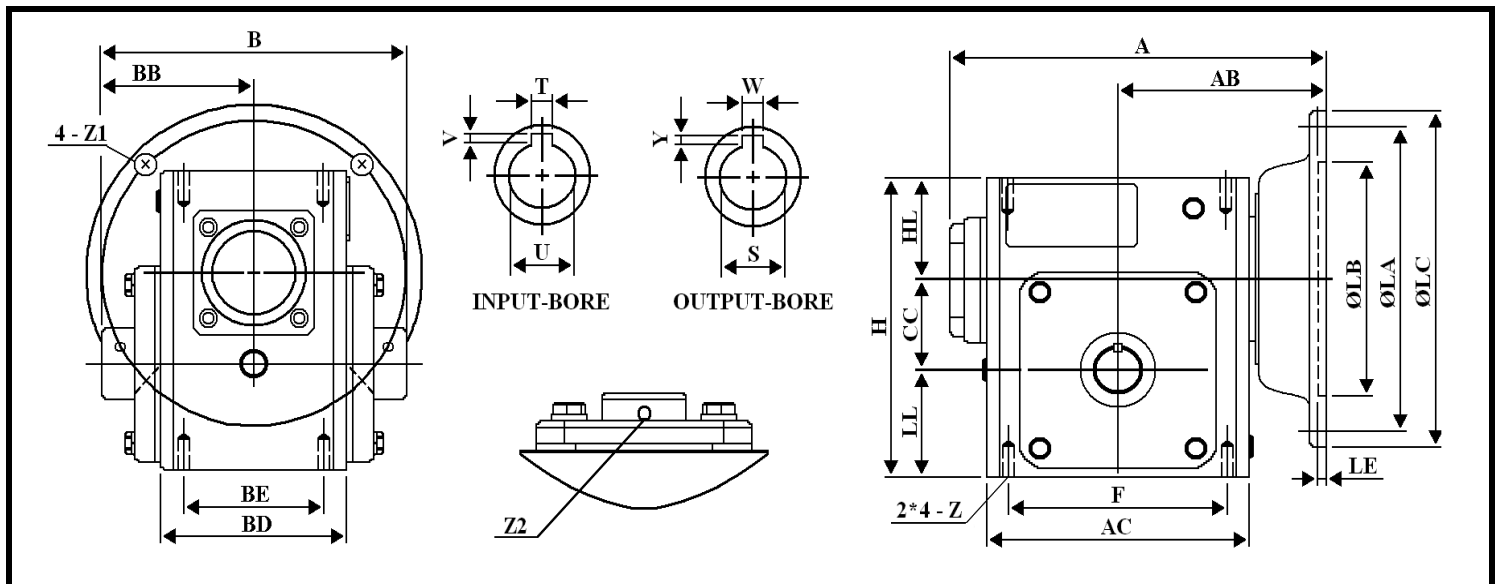
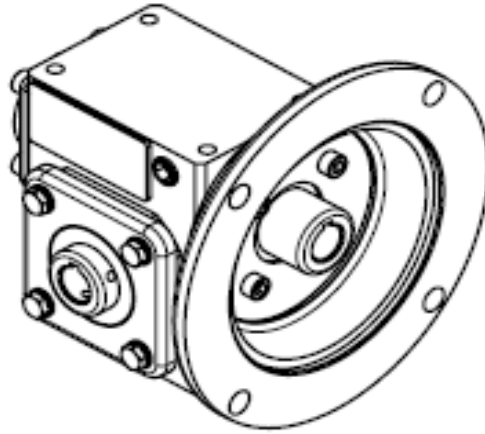

### DIMENSIONS - Inches

Size	A	AB	AC	B	BB	BD	BE	CC	F	H	HL	LL	Z2	Z
262	9.41	5.059	7.165	7	3.5	4.68	3.375	2.625	6.38	8	2.437	2.938	1/4-28 UNF*7/16	3/8-16 UNC

Size	INPUT BORE		OUTPUT BORE		FLANGE					NEMA FRAME	OIL (OZ.)
	U	T*V	S	W*Y	LA	LB	LC	LE	Z1		
262	0.625	3/16 * 3/32	1.437	3/8 * 3/16	5.875	4.5	6.5	0.157	0.433	56C	34.55

\* Suitable For Any Ratio

