

DATA SHEET

Premium Efficiency Motor: **WPMDC1-18-180V-56CB**

WorldWide Electric Corporation
1 (800) 808-2131
Worldwideelectric.net



Document Generated: 16-Sep-2024
Document ID:

Customer:

MOTOR INFORMATION

HP	1
RPM	1800
Poles	4
Armature Voltage	180V
Frame Size	56C
Enclosure	TEFC
Degree of Protection	IP54
Armature Full Load Amps	5.2
Full Load Torque	2.92 lb.ft.
Form Factor	1.00
Service Factor	1.00
Insulation Class	F
Max Ambient Temperature	40°C
Base Type	C-Face with Removable Base
Duty Cycle	Continuous
Shaft	KEYED
DE Bearing	6203
ODE Bearing	6203
Mounting	F3
Rotation	Bi-Directional
Wire Type	Loose Wire
Wire Housing	Junction Box
Approximate Weight	32 lbs.
Full Load Efficiency	82.0 %
Standard	CSA-US

MOTOR DRAWING

Premium Efficiency Motor: **WPMDC1-18-180V-56CB**

WorldWide Electric Corporation

1 (800) 808-2131

Worldwideelectric.net

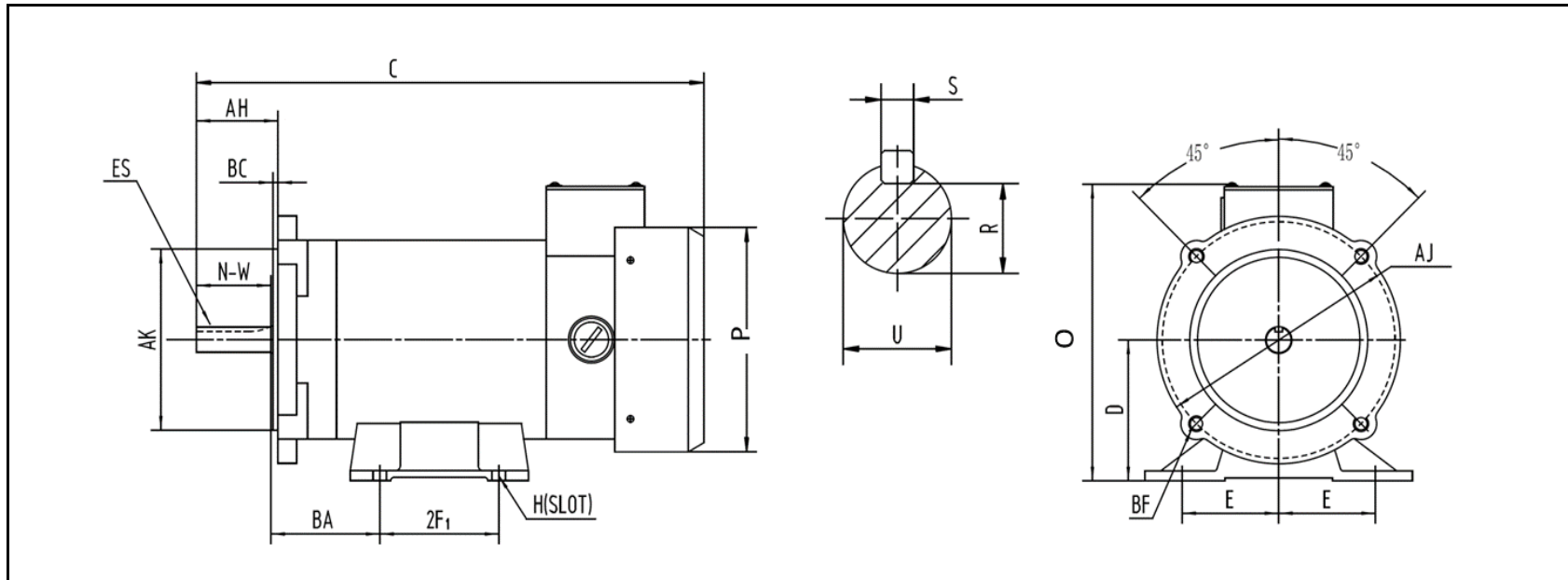

DIMENSION - INCHES

MOUNTING							C	D	O	P
E	E2	2F1	2F2	2F3	H	BA				
2.44	0	3	--	0	0.34	2.75	14.3	3.5	7.63	5.57

SHAFT & KEY				
S	ES	R	N-W	U
0.188	1.41	0.517	1.88	0.625

FLANGE				
AK	AJ	BF	AH	BC
4.5	5.875	4*3/8-16	2.06	0.12



WORLDWIDE ELECTRIC P.M.D.C.MOTOR

247070

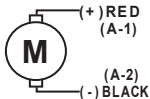
MODEL SER NO. HP RPM FR DUTY V.ARM A.ARM INS CL ENCL AMB F.F. 

MADE IN CHINA