

WORLDWIDE ELECTRIC MOTOR DRAWING

OCCP-254JM

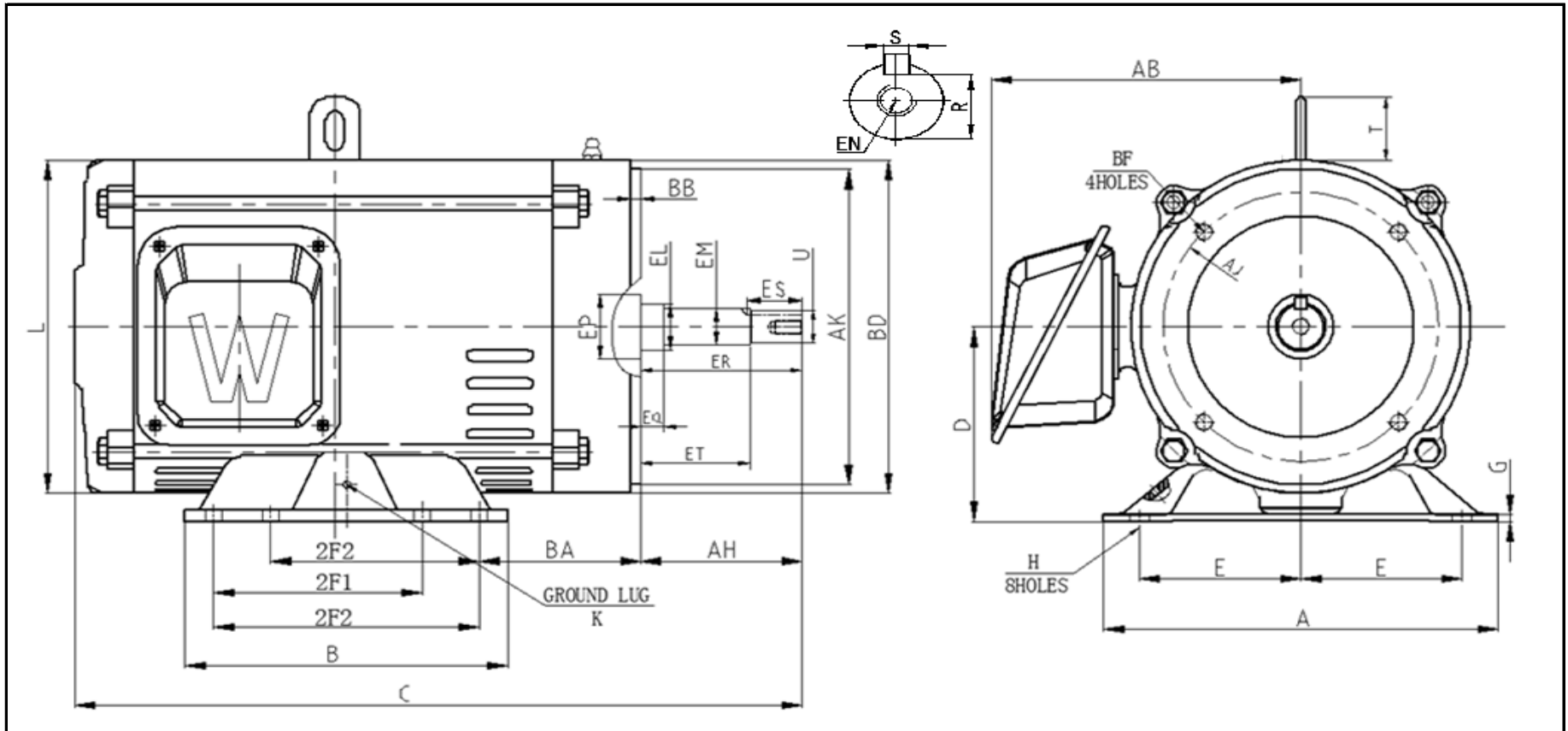

DIMENSIONS - INCHES

MOUNTING					A	B	C	D	G	AB	L	T	KEYSET	KEY	
E	2F1	2F2	H	BA									R	ES	S
5	8.25	10	0.53	4.75	12.05	11.57	23.94	6.25	0.47	9.7	10.6	2.48	1.1	2.53	0.25

FLANGE					AH	SHAFT EXTENSION								K
AK	AJ	BF	BB	BD		EL	EM	EP	EQ	ER	ET	EN	U	
8.5	7.25	1/2-13 * 0.75	0.256	10	5.25	1.75	1.375	1.75	0.625	5.25	3	1/2-13 * 1.0	1.25	M6