

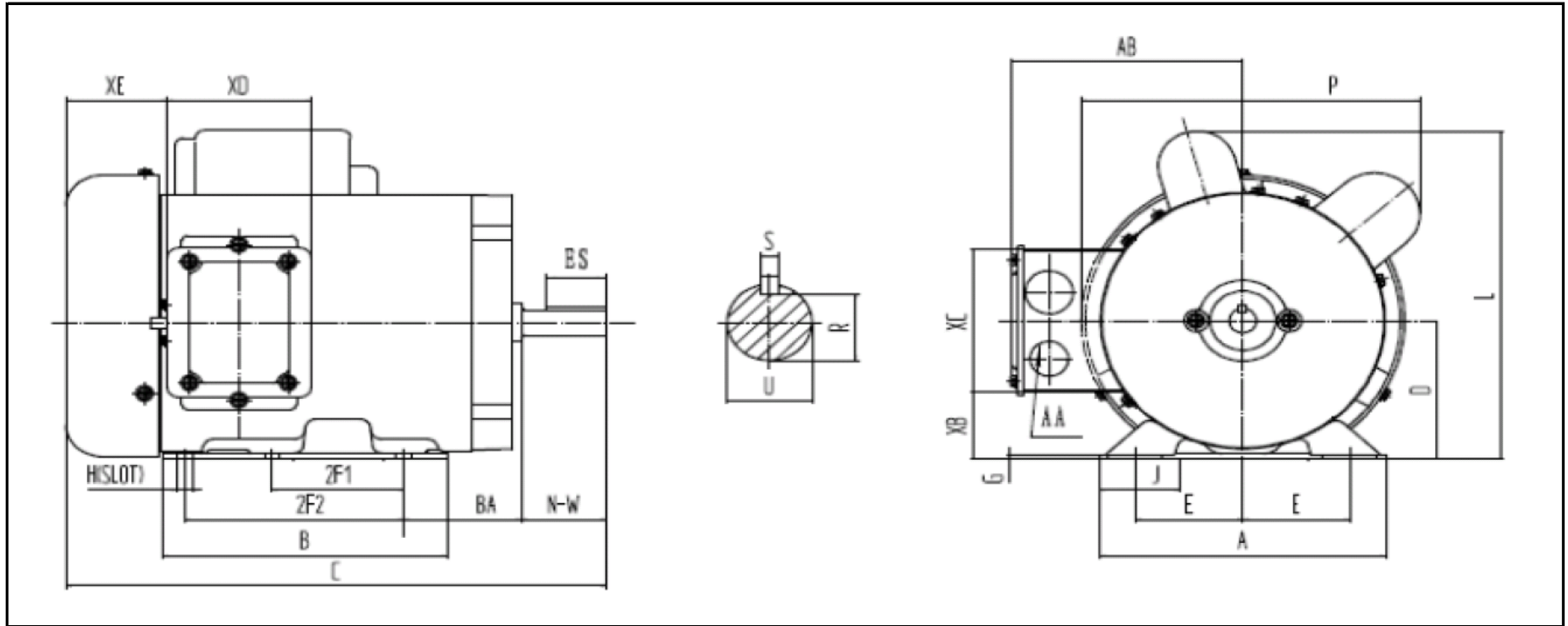

# WORLDWIDE ELECTRIC MOTOR DRAWING

## NTMOL2-36-56



**DIMENSIONS - INCHES**

MOUNTING					A	B	C	D	G	J	L	P	AB
E	2F1	2F2	H	BA									
2.44	3	5	0.34	2.75	6.54	6.54	12.9	3.5	0.12	1.65	8.7	8.2	5.2

KEY		KEYSET		SHAFT		TERMINAL BOX				
S	ES	R	N-W	U	AA	XB	XC	XD	XE	
0.188	1.41	0.517	1.88	0.625	2-0.88 / 2-1.109	1.65	3.7	3.2	2.15	