



WORLDWIDE ELECTRIC MOTOR DATA SHEET

NTMOL34-36-56



HORSEPOWER	3/4		
RPM / POLES	3600 / 2		
VOLTAGE / PHASE	115/230 V / 1		
FRAME	56		
ENCLOSURE / DEGREE OF PROTECTION	TEFC / IP43		
FREQUENCY	60 HZ		
FULL LOAD SPEED	3450 RPM		
SERVICE FACTOR	1.15		
INSULATION CLASS	F		
FULL LOAD AMPS; 115 / 230	9.2 / 4.6 A		
EFFICIENCY / POWER FACTOR	<u>LOAD</u>	<u>EFF.</u>	<u>P.F.</u>
	100%	66.5%	0.72
DUTY CYCLE	Continuous		
MAX. AMBIENT TEMPERATURE	40° C		
MAX. ELEVATION	3300 Ft. Above Sea Level		
TEMPERATURE RISE (At Full Load)	80° C		
THERMAL PROTECTOR	Manual		
DE BEARING	6203		
ODE BEARING	6203		
REGREASING INT. - DE BEARING	---		
REGREASING INT. - ODE BEARING	---		
GREASE TYPE	Mobil Polyrex EM		
MOUNTING	F1		
ROTATION	Bi-Directional		
CONNECTION DIAGRAM	115/230 V - 6 Lead		
APPROXIMATE WEIGHT	27 lbs.		
INVERTER RATING	---		
OPTIONS / ACCESSORIES	Base	---	
	Capacitor (Start)	NSC56-2 (400UF/165V)	
	Capacitor (Run)	---	
	Capacitor Cover (Start)	NSCCOVER56	
	Capacitor Cover (Run)	---	
	Centrifugal Switch	NCSWITCH56	
	Endbell (DE)	NDEEBELL56-1	
	Endbell (ODE)	NODEEBELL56	
	Fan	NFAN56	
	Fan Cover	NFCOVER56	
	Junction Box	NJBOX56	
Stationary Switch	NSSWITCH56		



WORLDWIDE ELECTRIC MOTOR DRAWING

NTMOL34-36-56

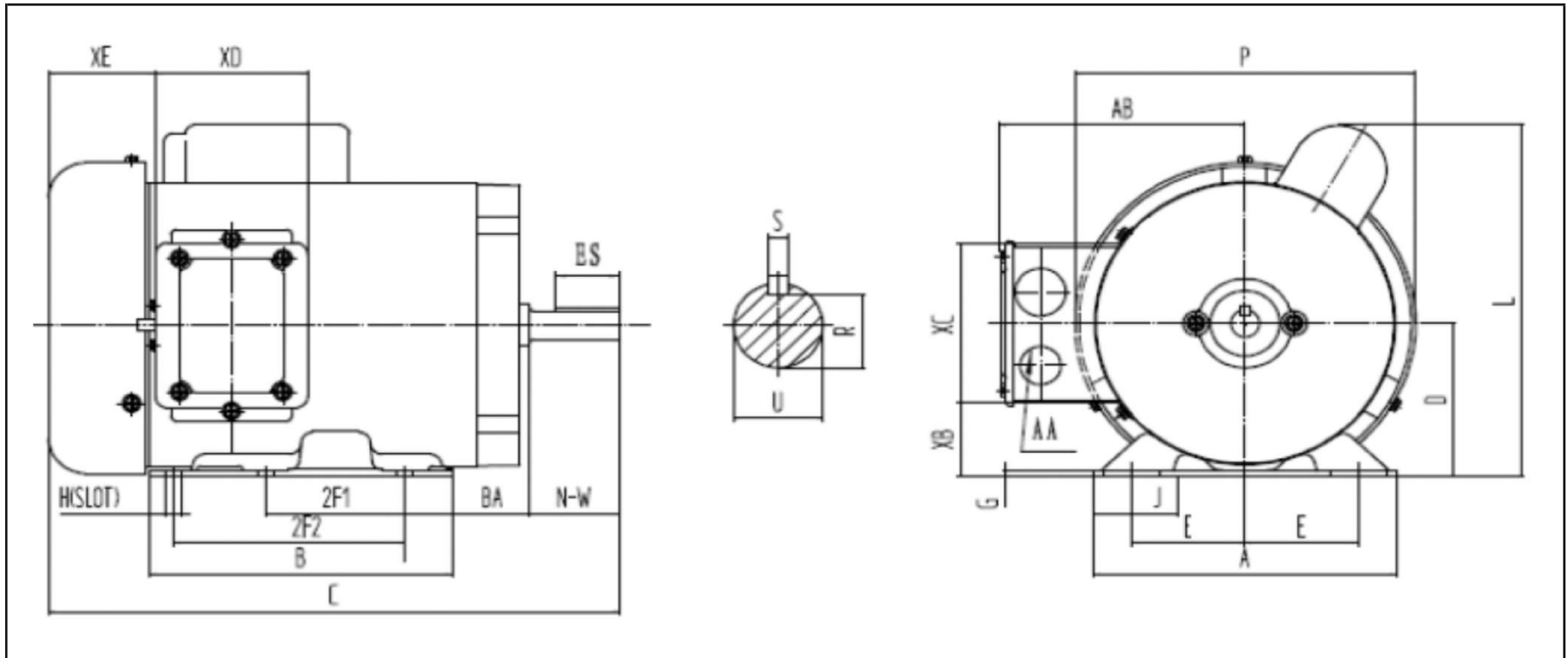

DIMENSIONS - INCHES

MOUNTING					A	B	C	D	G	J	L	P	AB
E	2F1	2F2	H	BA									
2.44	3	5	0.34	2.75	6.54	6.54	11.9	3.5	0.12	1.65	8.2	7.3	5.2

KEY		KEYSET	SHAFT		TERMINAL BOX				
S	ES	R	N-W	U	AA	XB	XC	XD	XE
0.188	1.41	0.517	1.88	0.625	2-0.88 / 2-1.109	1.65	3.7	3.2	2.15