

MOTOR DRAWING

Premium Efficiency Motor: **FM1-18-56C**

WorldWide Electric Corporation

1 (800) 808-2131

Worldwideelectric.net

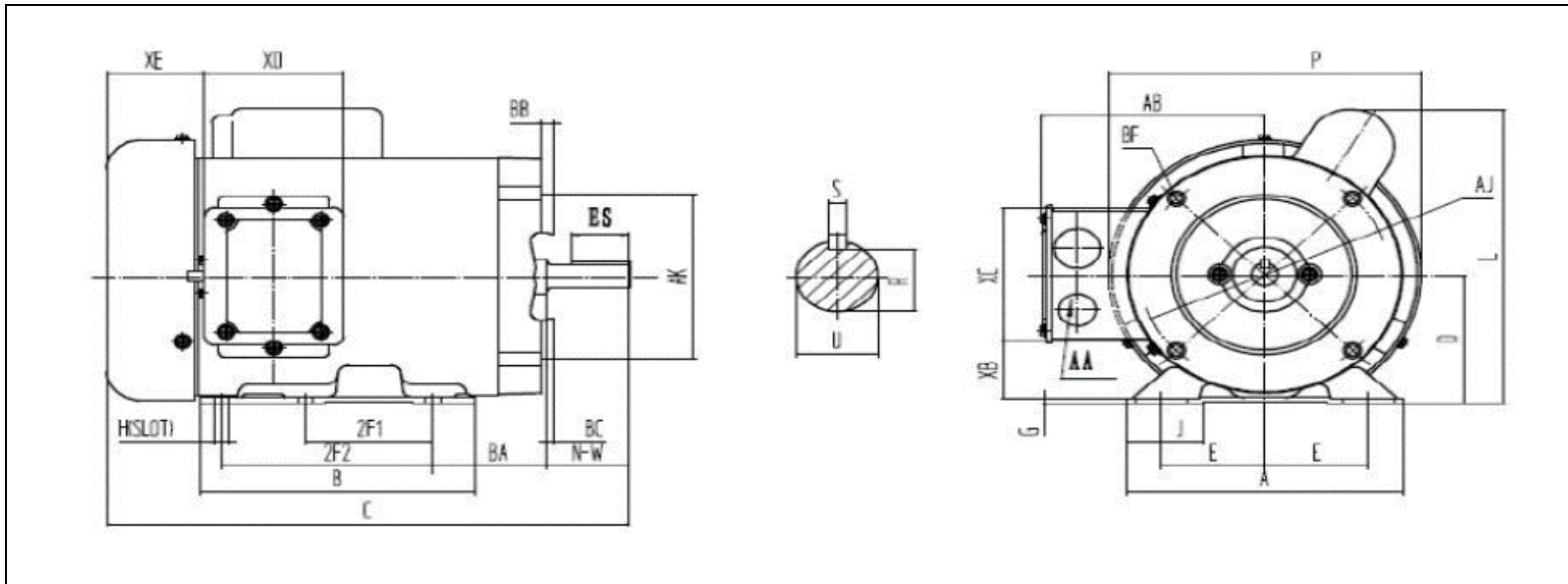

DIMENSION - INCHES

MOUNTING					A	B	C	D	G	L	P	AB	J
E	2F1	2F2	H	BA									
2.44	3	5	0.34	2.75	6.54	6.54	12.9	3.5	0.12	8.2	7.3	5.2	1.65

SHAFT & KEY				
R	ES	S	U	NW
0.517	1.41	0.188	0.625	1.88

TERMINAL BOX				
XB	XC	XD	XE	AA
1.65	3.7	3.2	2.15	2-0.88/2-1.109

FLANGE				
AK	AJ	BF	BB	BC
4.5	5.875	3/8-16	0.16	-0.19