

# DATA SHEET

Premium Efficiency Motor: **IEC13-36-63-C,**

**60 Hz**

WorldWide Electric Corporation

1 (800) 808-2131

Worldwideelectric.net



Document Generated: 17-Jul-2023  
Document ID:

Customer:

MOTOR INFORMATION	
HP	1/3
RPM	3600
Phase	3
Frequency	60
Voltage	230/460
Frame Size	63
Enclosure	TEFC
Degree of Protection	IP55
Service Factor	1.15
Poles	2
Full Load Speed	3454
Insulation Class	F
Temp Rise	80°C
NEMA Code Letter	L
Duty Cycle	S1
Slip	4.06%
IEC Design	N
Moment of Inertia	0.0048 lb.ft.^2
Locked Rotor Time (Hot)	12 seconds
Sound Pressure Level	72 dB(A)
Number of Starts	2 Hot / 3 Cold
Max Ambient Temperature	40° C
Max Elevation	1000 m.a.s.l (3300 f.a.s.l)
Mounting	B34 - C-Din Flange with Feet
Rotation	Bidirectional
Area of Classification	Safe
Inverter Rating	10:1 CT/20:1 VT
Standard	IEC 60034 and IEC 60072
Approvals	UL, CE

EFFICIENCY/POWER FACTOR		
LOAD	EFF	P. F.
100%	69.5 %	0.69
75%	73.2 %	0.59
50%	67.9 %	0.46

TORQUE		
FULL LOAD	LRT	BDT
0.6837 lb.ft.	400 %	482 %

AMPERAGE INFORMATION		
	230V	460V
Full Load Amps	1.21	0.61
Locked Rotor Amps	7.69	3.85
No Load Current	0.93	0.47

BEARING INFORMATION	
DE Bearing	6201 ZZ
ODE Bearing	6201 ZZ
Grease Type	NS7

ADDITIONAL DATA	
Multi-Mount	Yes
Shaft Material	AISI 1040/45
Connection Diagram	9 Lead Wye
Approximate Weight	TBD kg

# MOTOR DRAWING

Premium Efficiency Motor: IEC13-36-63-C

WorldWide Electric Corporation

1 (800) 808-2131

Worldwideelectric.net

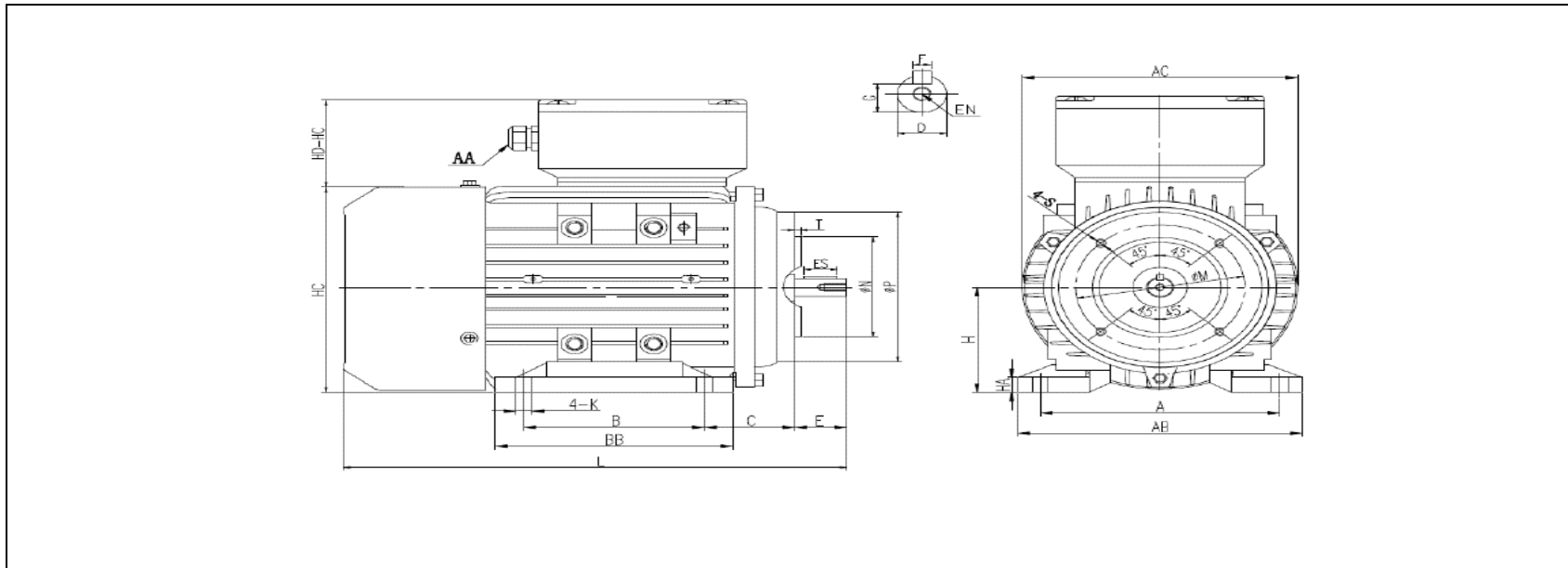

## DIMENSION - METRIC (mm)

MOUNTING				AB	BB	L	H	HA	AC	HC
A	B	C	K							
100	80	40	7	126	105	225	63	9	121	124

SHAFT & KEY					
F	ES	G	E	D	EN
4	15	8.5	23	11	M4*12mm

TERMINAL BOX	
AA	HD-HC
M20	55

FLANGE				
N	P	T	M	S
60	90	2.5	75	4*M5

# PERFORMANCE CURVES

Premium Efficiency Motor:

**IEC13-36-63-C**

WorldWide Electric Corporation

1 (800) 808-2131

Worldwideelectric.net



Document Generated: 17-Jul-2023	Customer:
Document ID:	

Motor Type					
Output Rating (HP)	1/3		FL Speed	3454	
Full Load Torque	0.684 lb.ft		LRT (%FLT)	400	460 volt FLA 0.61
Rotor Wk^2	0.0048 lb-ft^2		BDT (%FLT)	482	230 volt FLA 1.21

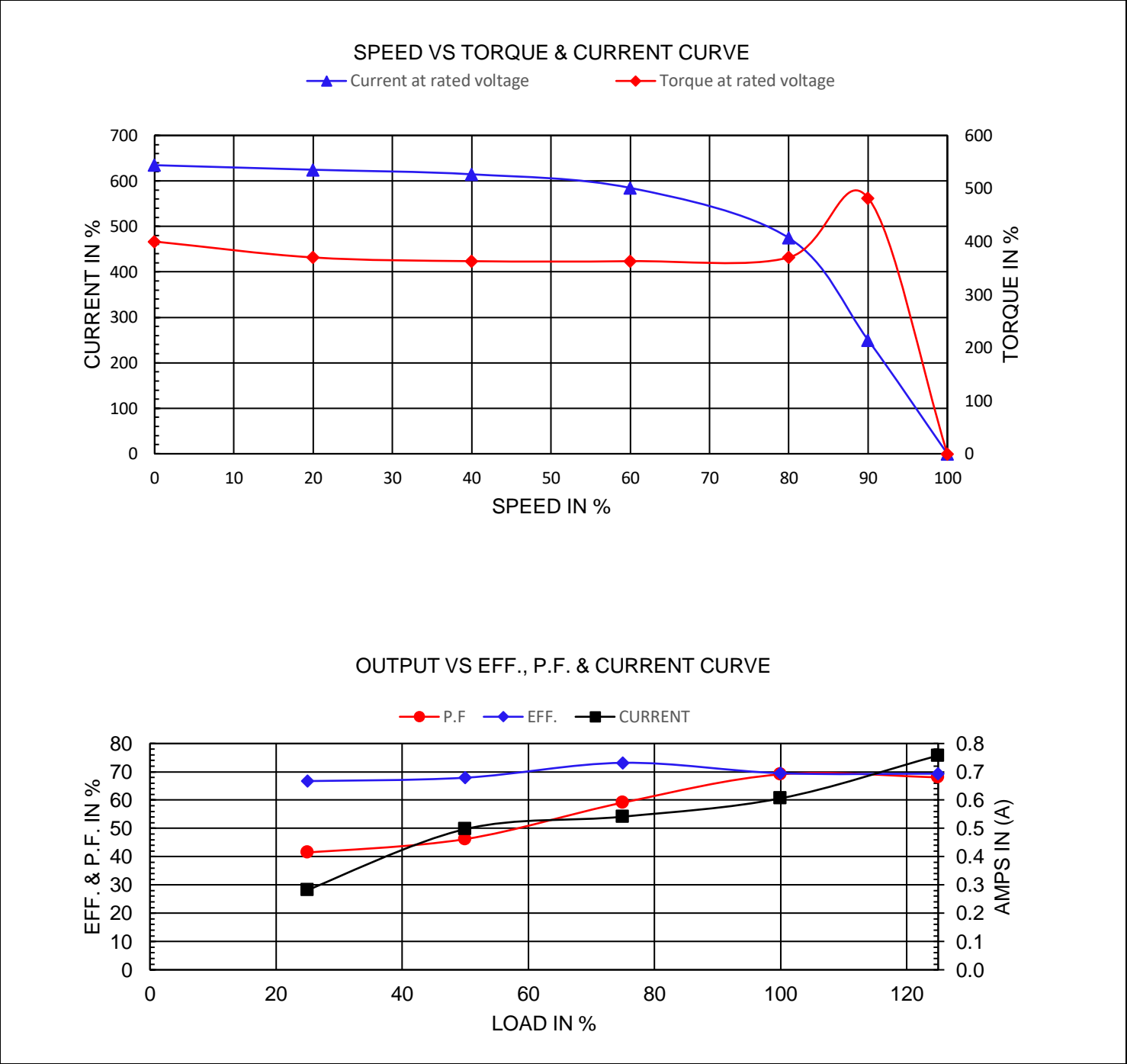

# NAMEPLATE / WIRING

Premium Efficiency Motor: **IEC13-36-63-C**

WorldWide Electric Corporation

1 (800) 808-2131





Worldwideelectric.net



Document Generated: 17-Jul-2023  
Document ID:

Customer:

## SAMPLE NAMEPLATE DATA

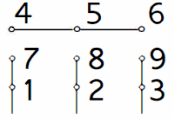
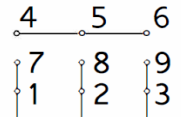
		<b>3-PHASE INDUCTION MOTOR</b>						<b>IE3 CE</b>	
		CC306B						IEC 60034-1	
TYPE		OUTPUT		HP	kW	INS.F	FR.	IP55	AMB.40°C
V	Hz	A	r/min	SF	IE CODE	η 100%	η 75%	η 50%	
				Code " "		" at 60Hz		Duty	S1
				DES		N		DE BRG	
2Y		Y		IC		411		ODE BRG	
				SN.		Date	Weight	kg	
<b>WorldWide Electric Corporation</b>									

TYPE	IEC13-36-63-C		OUTPUT	HP	1/3	kW	0.25	FRAME	63
V	Hz	A	r/min.	SF	IE CODE	η100%	η75%	η50%	
190/380	50	1.35/0.67	2796	1.00	IE3	69.7	72.3	69.0	
230/460	60	1.21/0.61	3454	1.15	IE3	69.5	73.2	67.9	

Code"	L	"at 60Hz	DE BRG	6201 ZZ	Weight	TBD kg
			ODE BRG	6201 ZZ		