

# DATA SHEET

Premium Efficiency Motor: **IEC2-12-100-C,**

**60 Hz**

WorldWide Electric Corporation

1 (800) 808-2131

Worldwideelectric.net



Document Generated: 17-Jul-2023  
Document ID:

Customer:

MOTOR INFORMATION	
HP	2
RPM	1200
Phase	3
Frequency	60
Voltage	230/460
Frame Size	100L
Enclosure	TEFC
Degree of Protection	IP55
Service Factor	1.15
Poles	6
Full Load Speed	1173
Insulation Class	F
Temp Rise	80°C
NEMA Code Letter	M
Duty Cycle	S1
Slip	2.28%
IEC Design	N
Moment of Inertia	0.3482 lb.ft.^2
Locked Rotor Time (Hot)	12 seconds
Sound Pressure Level	85 dB(A)
Number of Starts	2 Hot / 3 Cold
Max Ambient Temperature	40° C
Max Elevation	1000 m.a.s.l (3300 f.a.s.l)
Mounting	B34 - C-Din Flange with Feet
Rotation	Bidirectional
Area of Classification	Safe
Inverter Rating	10:1 CT/20:1 VT
Standard	IEC 60034 and IEC 60072
Approvals	UL, CE

EFFICIENCY/POWER FACTOR		
LOAD	EFF	P. F.
100%	88.5 %	0.66
75%	88.2 %	0.57
50%	86.1 %	0.44

TORQUE		
FULL LOAD	LRT	BDT
8.959 lb.ft.	333 %	376 %

AMPERAGE INFORMATION		
	230V	460V
Full Load Amps	6.48	3.24
Locked Rotor Amps	51.30	25.65
No Load Current	4.46	2.23

BEARING INFORMATION	
DE Bearing	6206 ZZ
ODE Bearing	6305 ZZ
Grease Type	NS7

ADDITIONAL DATA	
Multi-Mount	Yes
Shaft Material	AISI 1040/45
Connection Diagram	9 Lead Wye
Approximate Weight	TBD kg

# MOTOR DRAWING

Premium Efficiency Motor: **IEC2-12-100-C**

WorldWide Electric Corporation

1 (800) 808-2131

Worldwideelectric.net

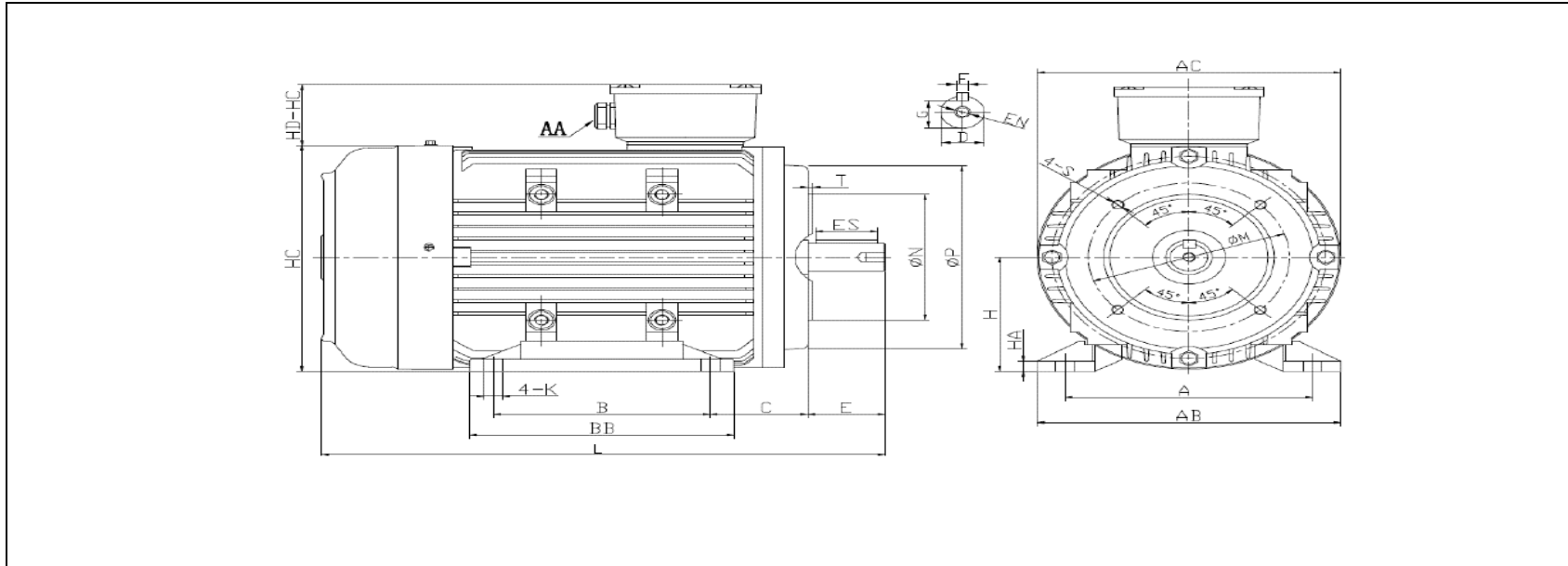

## DIMENSION - METRIC (mm)

MOUNTING				AB	BB	L	H	HA	AC	HC
A	B	C	K							
160	140	63	12	198	171	368	100	11	196	198

SHAFT & KEY					
F	ES	G	E	D	EN
8	50	24	60	28	M10*20mm

TERMINAL BOX	
AA	HD-HC
M20	52

FLANGE				
N	P	T	M	S
110	160	3.5	130	4*M8

# PERFORMANCE CURVES

Premium Efficiency Motor:

**IEC2-12-100-C**

WorldWide Electric Corporation

1 (800) 808-2131

Worldwideelectric.net



Document Generated: 17-Jul-2023	Customer:
Document ID:	

Motor Type					
Output Rating (HP)	2	FL Speed	1173		
Full Load Torque	8.959 lb.ft	LRT (%FLT)	333	460 volt FLA	3.24
Rotor Wk <sup>2</sup>	0.3482 lb-ft <sup>2</sup>	BDT (%FLT)	376	230 volt FLA	6.48

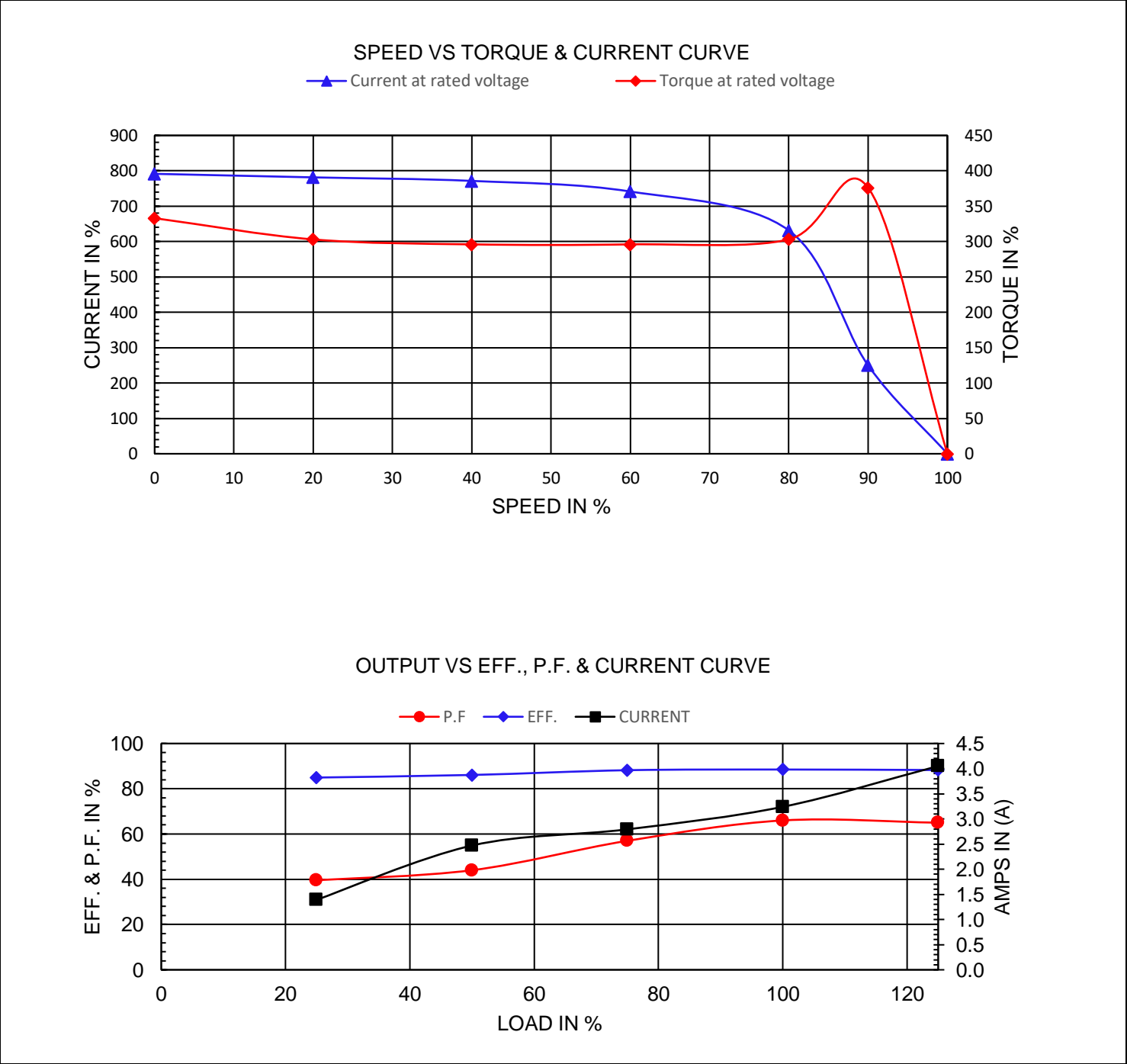

# NAMEPLATE / WIRING

Premium Efficiency Motor: **IEC2-12-100-C**

WorldWide Electric Corporation

1 (800) 808-2131

Worldwideelectric.net



Document Generated: 17-Jul-2023  
Document ID:

Customer:

## SAMPLE NAMEPLATE DATA

		<b>3-PHASE INDUCTION MOTOR</b>						<b>IE3 CE</b>			
						<small>CC306B</small>		<small>IEC 60034-1</small>			
TYPE		OUTPUT		HP	kW	INS.F	FR.	IP55	AMB.40°C		
V	Hz	A	r/min	SF	IE CODE	η 100%	η 75%	η 50%			
				Code " " at 60Hz			Duty	S1			
				DES	N	DE BRG					
				IC	411	ODE BRG					
				SN.		Date	Weight	kg			

TYPE	IEC2-12-100-C		OUTPUT	HP	2	kW	1.49	FRAME	100L
V	Hz	A	r/min.	SF	IE CODE	η100%	η75%	η50%	
190/380	50	7.33/3.66	963	1.00	IE3	82.5	87.0	86.1	
230/460	60	6.48/3.24	1173	1.15	IE3	88.5	88.2	86.1	

Code"	M	"at 60Hz	DE BRG	6206 ZZ	Weight	TBD kg
			ODE BRG	6305 ZZ		