

DATA SHEET

Premium Efficiency Motor: **IEC2-36-90,**

60 Hz

WorldWide Electric Corporation

1 (800) 808-2131

Worldwideelectric.net



Document Generated: 14-Jul-2023
Document ID:

Customer:

MOTOR INFORMATION	
HP	2
RPM	3600
Phase	3
Frequency	60
Voltage	230/460
Frame Size	90S
Enclosure	TEFC
Degree of Protection	IP55
Service Factor	1.15
Poles	2
Full Load Speed	3513
Insulation Class	F
Temp Rise	80°C
NEMA Code Letter	L
Duty Cycle	S1
Slip	2.42%
IEC Design	N
Moment of Inertia	0.0485 lb.ft.^2
Locked Rotor Time (Hot)	12 seconds
Sound Pressure Level	85 dB(A)
Number of Starts	2 Hot / 3 Cold
Max Ambient Temperature	40° C
Max Elevation	1000 m.a.s.l (3300 f.a.s.l)
Mounting	F3
Rotation	Bidirectional
Area of Classification	Safe
Inverter Rating	10:1 CT/20:1 VT
Standard	IEC 60034 and IEC 60072
Approvals	UL, CE

EFFICIENCY/POWER FACTOR		
LOAD	EFF	P. F.
100%	85.5 %	0.83
75%	85.7 %	0.76
50%	83.0 %	0.64

TORQUE		
FULL LOAD	LRT	BDT
4.078 lb.ft.	345 %	437 %

AMPERAGE INFORMATION		
	230V	460V
Full Load Amps	5.28	2.64
Locked Rotor Amps	49.18	24.59
No Load Current	2.67	1.34

BEARING INFORMATION	
DE Bearing	6205 ZZ
ODE Bearing	6304 ZZ
Grease Type	NS7

ADDITIONAL DATA	
Multi-Mount	Yes
Shaft Material	AISI 1040/45
Connection Diagram	9 Lead Wye
Approximate Weight	15.4 kg

MOTOR DRAWING

Premium Efficiency Motor: **IEC2-36-90**

WorldWide Electric Corporation

1 (800) 808-2131

Worldwideelectric.net

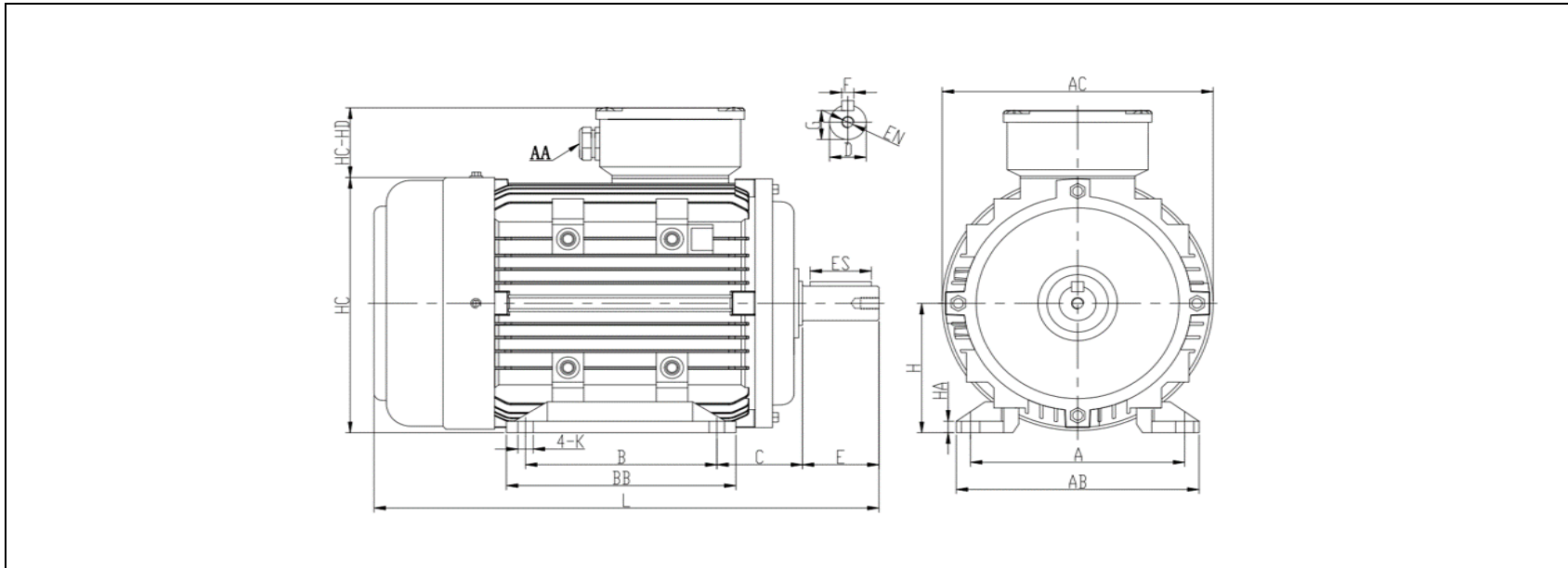

DIMENSION - METRIC (mm)

MOUNTING					L	H	HA	AC	HC	K
A	B	C	AB	BB						
140	100	56	159	125	305	90	8	175	177.5	10

SHAFT & KEY					
F	ES	G	E	D	EN
8	35	20	50	24	M8-25mm

TERMINAL BOX	
AA	HD-HC
M20	49

PERFORMANCE CURVES

Premium Efficiency Motor: **IEC2-36-90**

WorldWide Electric Corporation

1 (800) 808-2131

Worldwideelectric.net



Document Generated: 14-Jul-2023	Customer:
Document ID:	

Motor Type					
Output Rating (HP)	2		FL Speed	3513	
Full Load Torque	4.078 lb.ft		LRT (%FLT)	345	460 volt FLA 2.64
Rotor Wk^2	0.0485 lb-ft^2		BDT (%FLT)	437	230 volt FLA 5.28

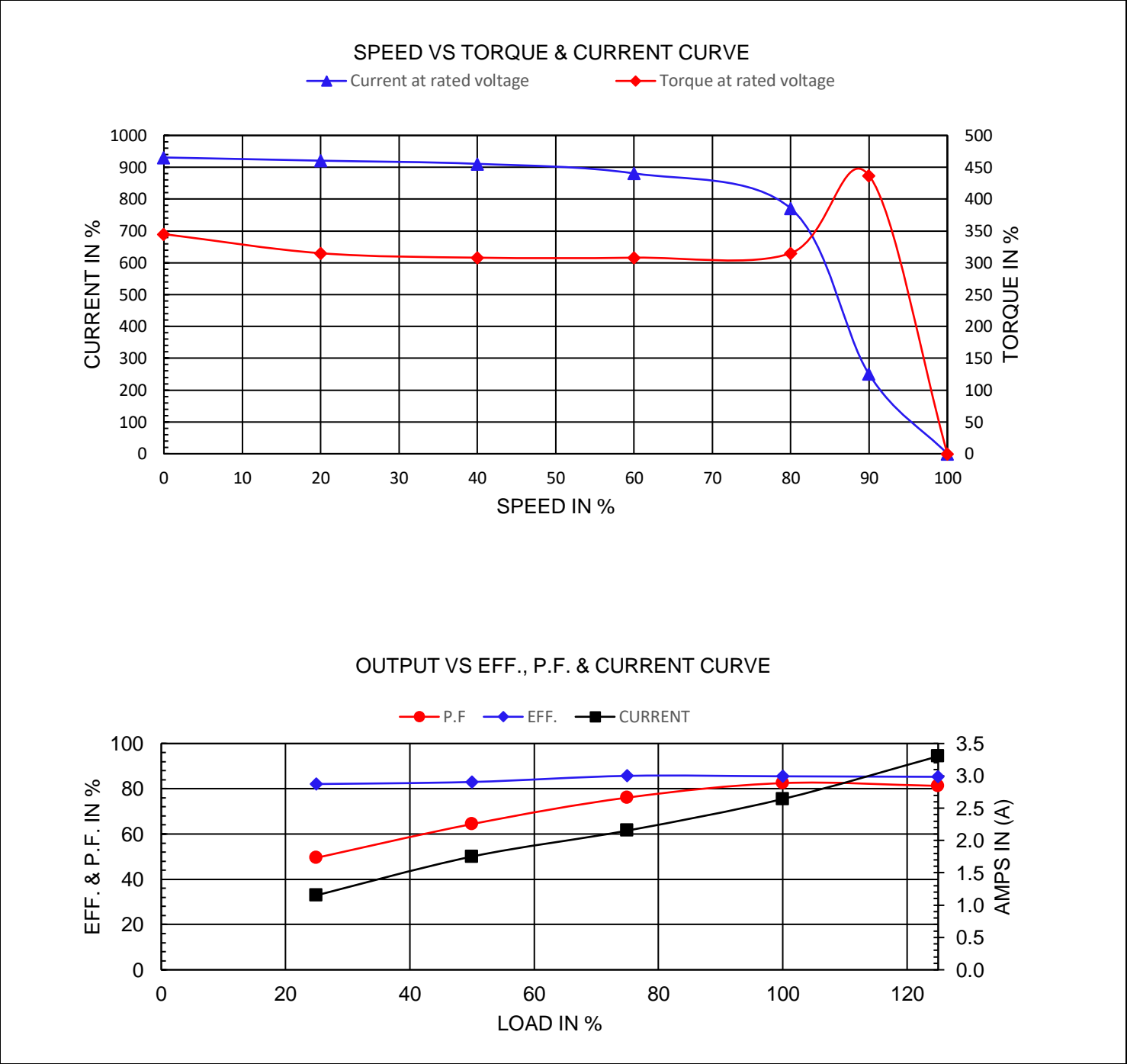

NAMEPLATE / WIRING

Premium Efficiency Motor: **IEC2-36-90**

WorldWide Electric Corporation

1 (800) 808-2131





Worldwideelectric.net

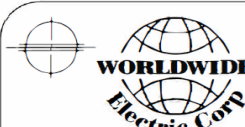

Document Generated: 14-Jul-2023
Document ID:

Customer:

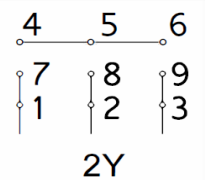
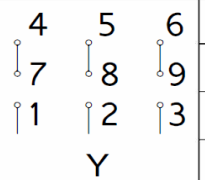
SAMPLE NAMEPLATE DATA

		3-PHASE INDUCTION MOTOR						IE3 CE			
		CC306B						IEC 60034-1			
TYPE		OUTPUT		HP	kW	INS.F	FR.	IP55	AMB.40°C		
V	Hz	A	r/min	SF	IE CODE		η 100%	η 75%	η 50%		
				Code " " at 60Hz			Duty		S1		
				DES	N	DE BRG					
				IC	411	ODE BRG					
				SN.		Date		Weight	kg		
											

TYPE	IEC2-36-90		OUTPUT	HP	2	kW	1.49	FRAME	90S
V	Hz	A	r/min.	SF	IE CODE	η100%	η75%	η50%	
190/380	50	6.23/3.11	2882	1.00	IE3	84.2	85.5	84.8	
230/460	60	5.28/2.64	3513	1.15	IE3	85.5	85.7	83.0	

Code"	L	"at 60Hz	DE BRG	6205 ZZ	Weight	15.4 kg
			ODE BRG	6304 ZZ		