

DATA SHEET

Premium Efficiency Motor: **IEC4-12-132-C,**

60 Hz

WorldWide Electric Corporation

1 (800) 808-2131

Worldwideelectric.net



Document Generated: 17-Jul-2023
Document ID:

Customer:

MOTOR INFORMATION	
HP	4
RPM	1200
Phase	3
Frequency	60
Voltage	230/460
Frame Size	132S
Enclosure	TEFC
Degree of Protection	IP55
Service Factor	1.15
Poles	6
Full Load Speed	1171
Insulation Class	F
Temp Rise	80°C
NEMA Code Letter	L
Duty Cycle	S1
Slip	2.45%
IEC Design	N
Moment of Inertia	0.6664 lb.ft.^2
Locked Rotor Time (Hot)	12 seconds
Sound Pressure Level	88 dB(A)
Number of Starts	2 Hot / 3 Cold
Max Ambient Temperature	40° C
Max Elevation	1000 m.a.s.l (3300 f.a.s.l)
Mounting	B34 - C-Din Flange with Feet
Rotation	Bidirectional
Area of Classification	Safe
Inverter Rating	10:1 CT/20:1 VT
Standard	IEC 60034 and IEC 60072
Approvals	UL, CE

EFFICIENCY/POWER FACTOR		
LOAD	EFF	P. F.
100%	89.5 %	0.74
75%	89.7 %	0.65
50%	88.4 %	0.51

TORQUE		
FULL LOAD	LRT	BDT
18.07 lb.ft.	353 %	382 %

AMPERAGE INFORMATION		
	230V	460V
Full Load Amps	11.43	5.71
Locked Rotor Amps	93.14	46.57
No Load Current	7.16	3.58

BEARING INFORMATION	
DE Bearing	6308 ZZ
ODE Bearing	6306 ZZ
Grease Type	NS7

ADDITIONAL DATA	
Multi-Mount	Yes
Shaft Material	AISI 1040/45
Connection Diagram	9 Lead Wye
Approximate Weight	TBD kg

MOTOR DRAWING

Premium Efficiency Motor: IEC4-12-132-C

WorldWide Electric Corporation

1 (800) 808-2131

Worldwideelectric.net

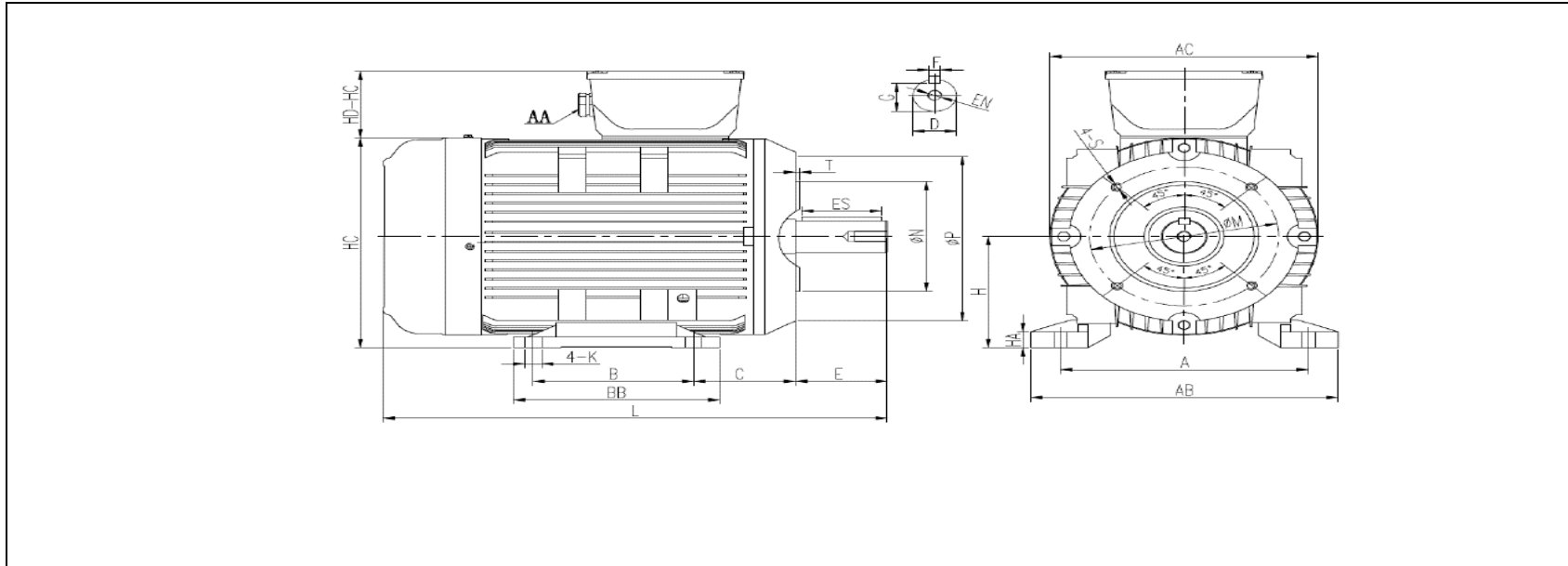

DIMENSION - METRIC (mm)

MOUNTING				AB	BB	L	H	HA	AC	HC
A	B	C	K							
216	140	89	12	268	185	467	132	17	234	249

SHAFT & KEY					
F	ES	G	E	D	EN
10	70	33	80	38	M12*30mm

TERMINAL BOX	
AA	HD-HC
M32	80

FLANGE				
N	P	T	M	S
130	200	3	165	4*M10

PERFORMANCE CURVES

Premium Efficiency Motor:

IEC4-12-132-C

WorldWide Electric Corporation

1 (800) 808-2131

Worldwideelectric.net



Document Generated: 17-Jul-2023	Customer:
Document ID:	

Motor Type					
Output Rating (HP)	4	FL Speed	1171		
Full Load Torque	18.070 lb.ft	LRT (%FLT)	353	460 volt FLA	5.71
Rotor Wk^2	0.6664 lb-ft^2	BDT (%FLT)	382	230 volt FLA	11.43

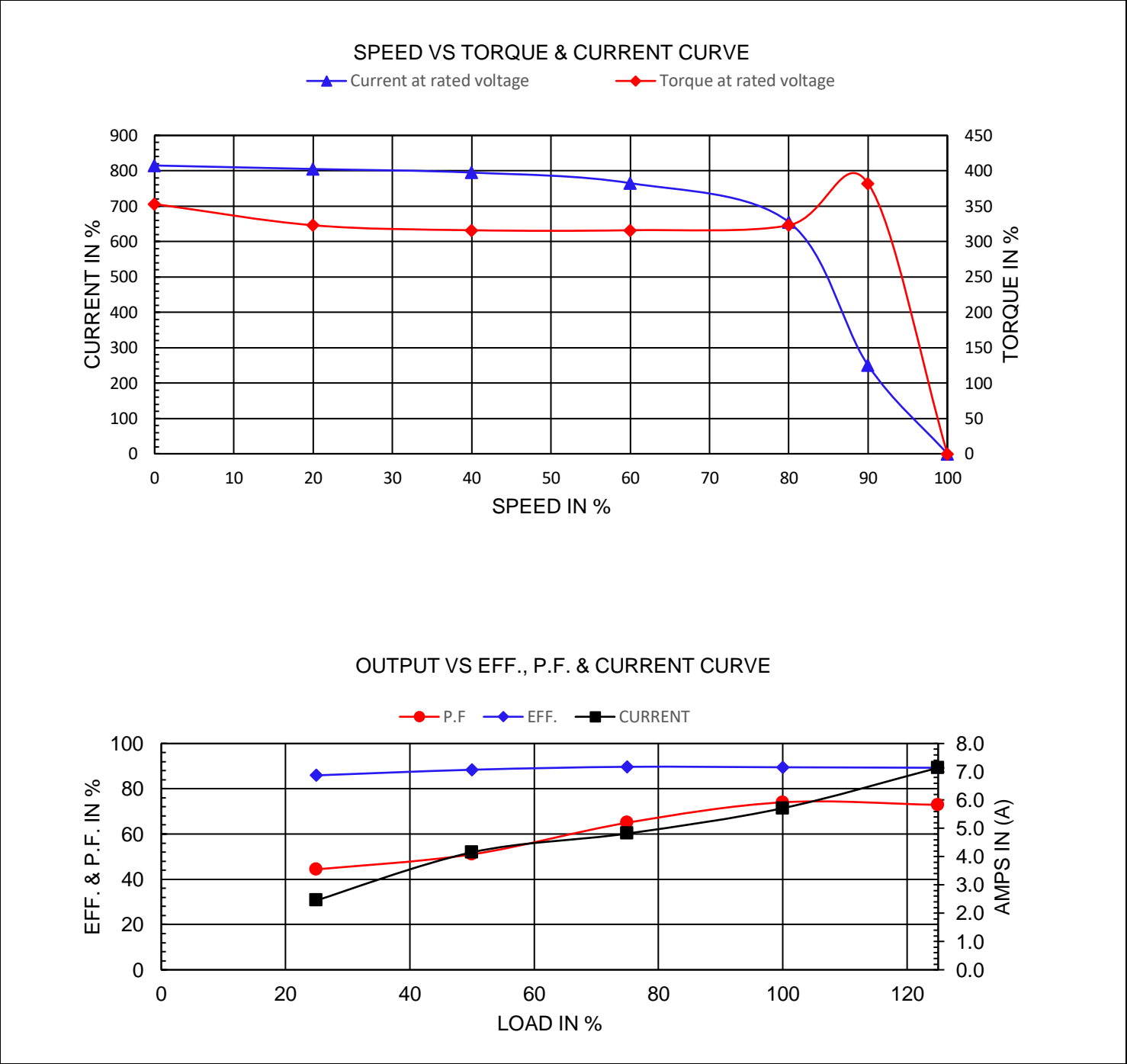

NAMEPLATE / WIRING

Premium Efficiency Motor: **IEC4-12-132-C**

WorldWide Electric Corporation

1 (800) 808-2131



Worldwideelectric.net



Document Generated: 17-Jul-2023
Document ID:

Customer:

SAMPLE NAMEPLATE DATA

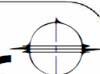
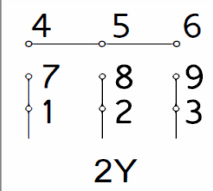
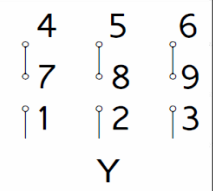
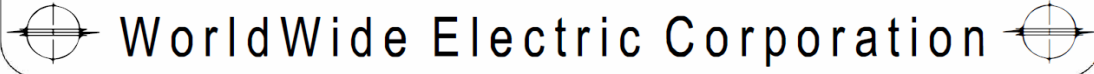
		3-PHASE INDUCTION MOTOR						IE3 CE			
		CC306B						IEC 60034-1			
TYPE		OUTPUT		HP	kW	INS.F	FR.	IP55	AMB.40°C		
V	Hz	A	r/min	SF	IE CODE	η 100%	η 75%	η 50%			
				Code " " at 60Hz		Duty		S1			
				DES	N	DE BRG					
				IC	411	ODE BRG					
				SN.		Date	Weight	kg			
											

TYPE	IEC4-12-132-C		OUTPUT	HP	4	kW	2.98	FRAME	132S
V	Hz	A	r/min.	SF	IE CODE	η100%	η75%	η50%	
190/380	50	13.12/6.56	960	1.00	IE3	85.6	88.5	88.5	
230/460	60	11.43/5.71	1171	1.15	IE3	89.5	89.7	88.4	

Code"	L	"at 60Hz	DE BRG	6308 ZZ	Weight	TBD kg
			ODE BRG	6306 ZZ		