

1 2 3 4 5 6 7 8 9

A
B
C
D
E
F

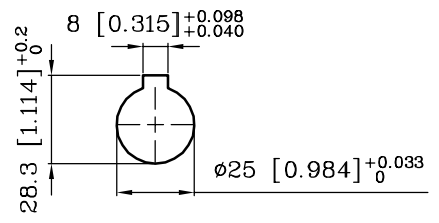

OUTPUT BORE

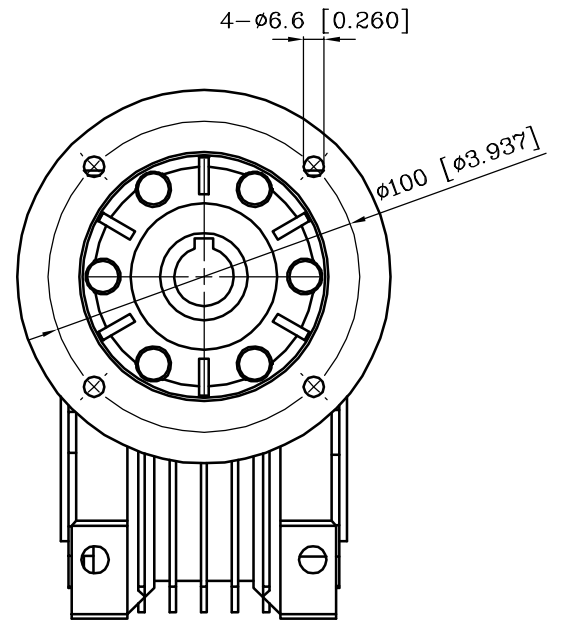
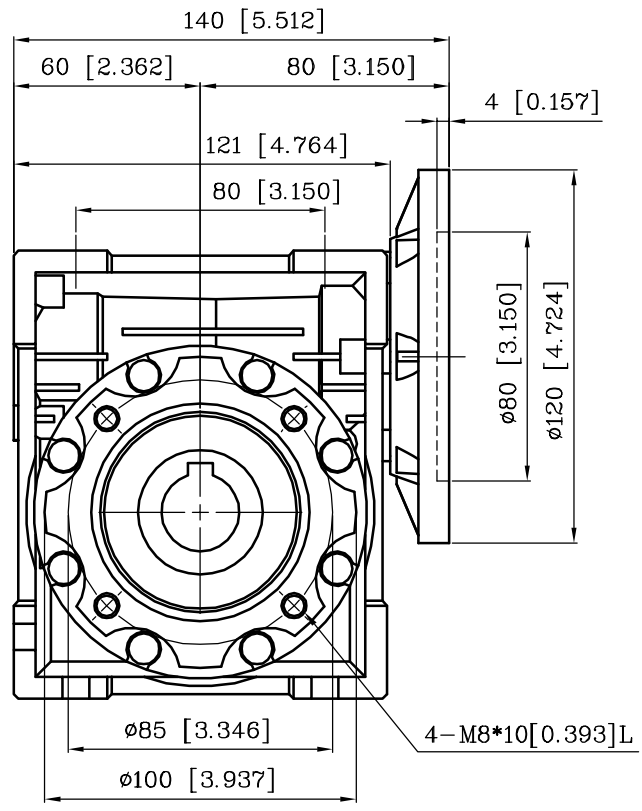
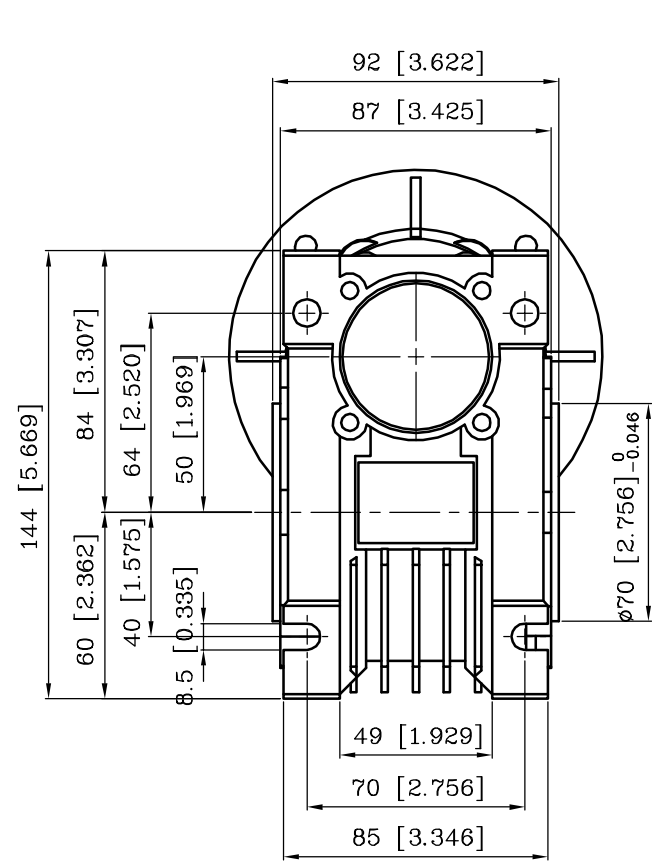
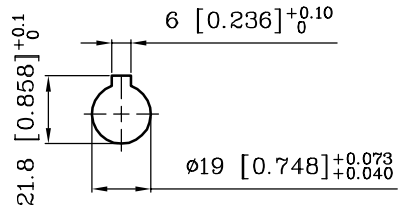

INPUT BORE

WORLDWIDE				
NAME		DATE	TITLE : CALM50-80B14	
DWN.	CHUN-YA	2023.02.01	DWG. NO : CALM50-80B14	
DESIGN.			PROJECTION	3RD. ANGLE
APPR.			SCALE	1:25
			E-mail:	REV: A