

1 2 3 4 5 6 7 8 9

A
B
C
D
E
F

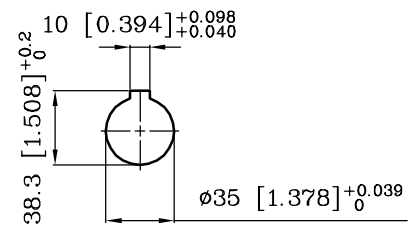

OUTPUT BORE

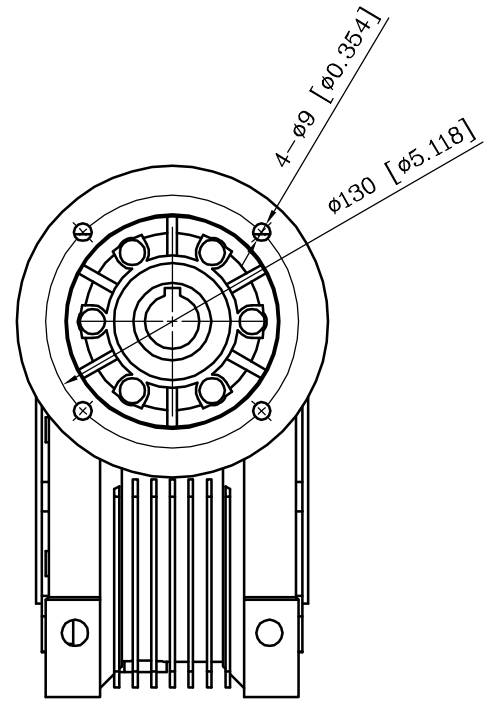
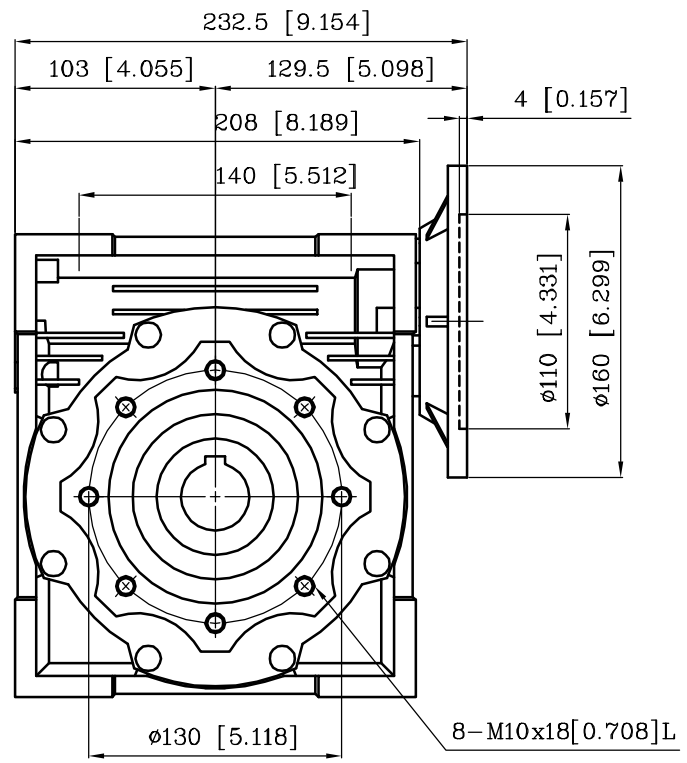
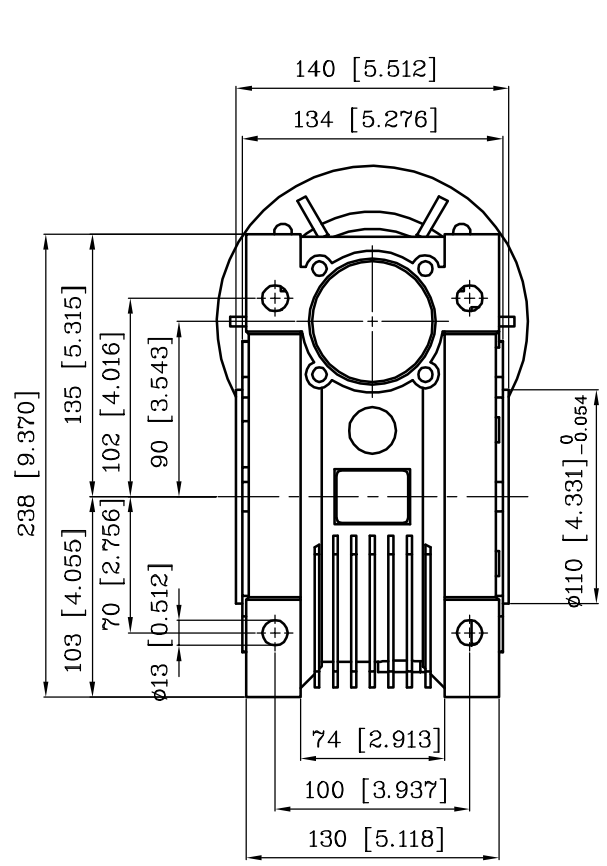
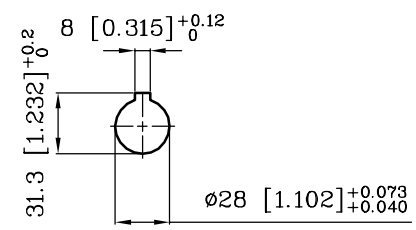

INPUT BORE

WORLDWIDE

	NAME	DATE	TITLE : CALM90-112B14		
DWN.	CHUN-YA	2023.02.01	DWG. NO : CALM90-112B14		
DESN.			PROJECTION	3RD. ANGLE	E-mail:
APPR.			SCALE	1:4	REV: A