

1 2 3 4 5 6 7 8 9

A

B

C

D

E

F

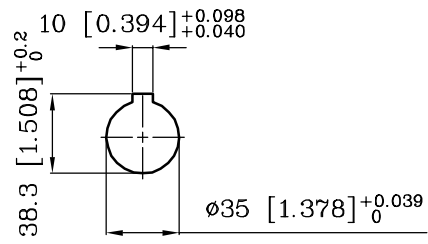
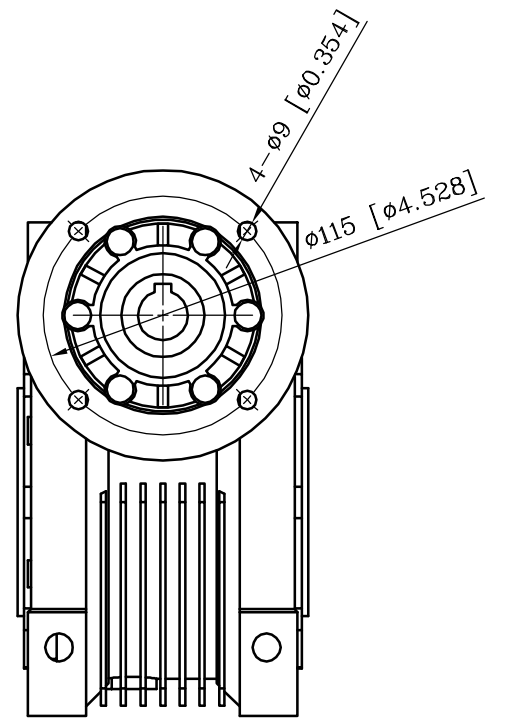
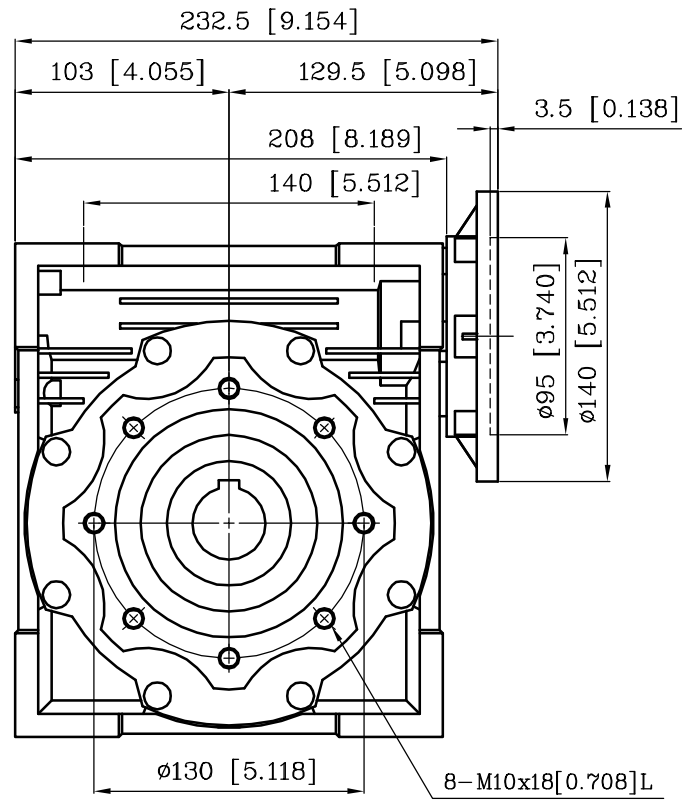
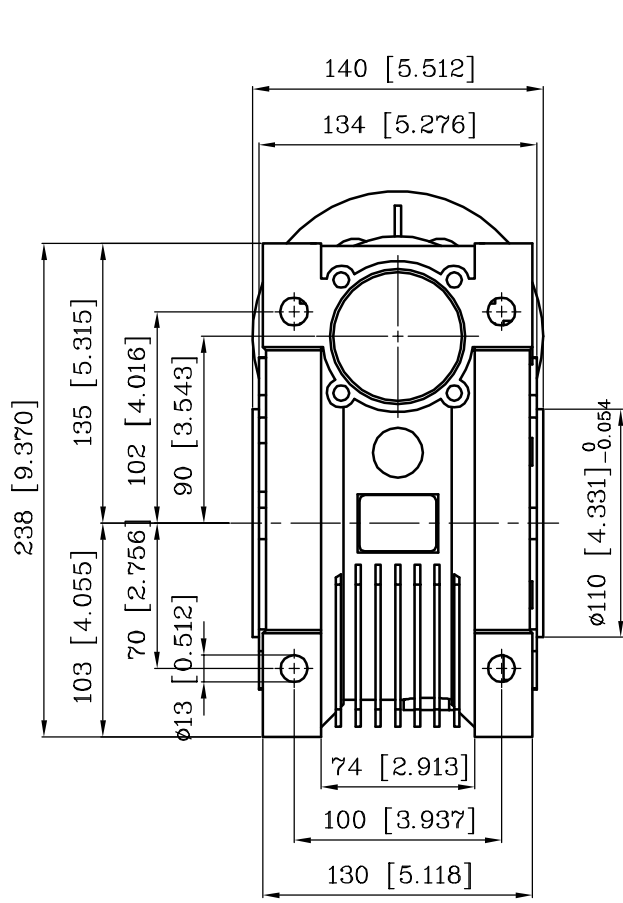

OUTPUT BORE

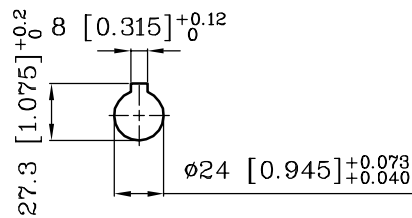

INPUT BORE

# WORLDWIDE

	NAME	DATE	TITLE : CALM90-90B14		
DWN.	CHUN-YA	2023.02.01	DWG. NO : CALM90-90B14		
DESN.			PROJECTION	3RD. ANGLE	E-mail:
APPR.			SCALE	1:3.75	REV: A