



# WORLDWIDE ELECTRIC MOTOR DATA SHEET

## IXPEWWE7.5-18-213T



HORSEPOWER	7.5		
RPM / POLES	1800 / 4		
VOLTAGE / PHASE	230 / 460 V / 3		
FRAME	213T		
ENCLOSURE / DEGREE OF PROTECTION	TEFC / IP55		
FREQUENCY	60 HZ Suitable For 50 HZ Operation With 1.0 SF		
FULL LOAD SPEED	1773 RPM		
SERVICE FACTOR	1.15 SF		
INSULATION CLASS	F		
FULL LOAD AMPS	17.8 / 8.9 A		
LOCKED ROTOR AMPS (STARTING)	127 / 63.5 A		
NO LOAD CURRENT			
NEMA CODE LETTER	H		
EFFICIENCY / POWER FACTOR	<u>LOAD</u>	<u>EFF.</u>	<u>P.F.</u>
	100%	91.7%	0.84
	75%	91.5%	0.82
	50%	89.0%	0.74
DUTY CYCLE	S1 / Continuous		
TORQUE	<u>FULL LOAD</u>	<u>LRT</u>	<u>BDT</u>
	22.3 lb.ft.	175%	215%
SLIP	1.50%		
NEMA DESIGN	B		
MOMENT OF INERTIA			
NUMBER OF STARTS (Hot / Cold)	1 Hot / 2 Cold (Per Hour)		
MAX. AMBIENT TEMPERATURE	40° C		
MAX. ELEVATION	3300 Ft. Above Sea Level		
TEMPERATURE RISE (At Full Load)	80° C		
DE BEARING	6308-ZZ		
ODE BEARING	6308-ZZ		
GREASE TYPE	Mobil Polyrex EM		
MOUNTING	F1		
ROTATION	Bi-Directional		
APPROXIMATE WEIGHT	254 lbs.		
TEMPERATURE CODE AT 40°C AMBIENT	T3C		
TEMPERATURE CODE AT 55°C AMBIENT	T3C		
AREA CLASSIFICATION	Class I, Division I, Groups C & D		
	Class II, Division I, Groups F & G		
INVERTER RATING	5:1 CT / 10:1 VT PWM Type		





WORLDWIDE ELECTRIC MOTOR DRAWING

IXPEWWE-213T

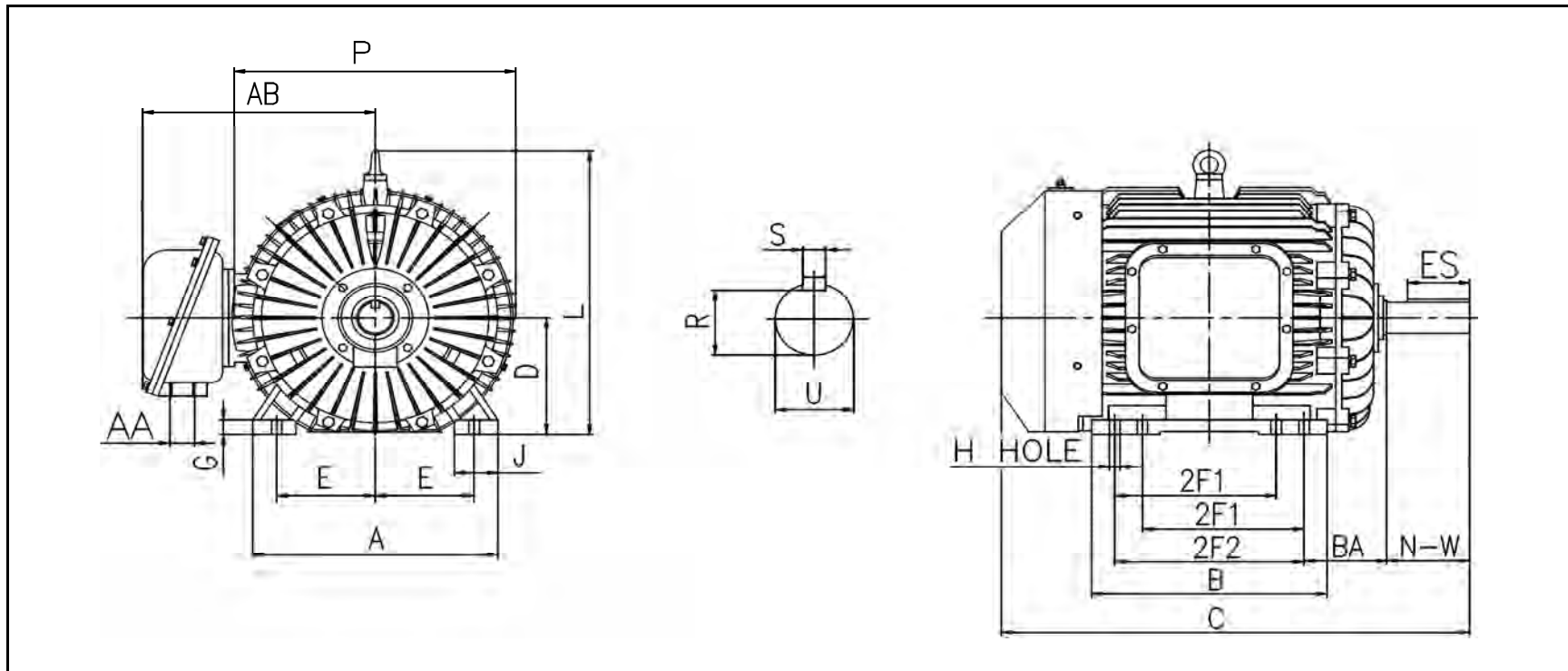

MOUNTING					A	B	C	D	G	J
E	2F1	2F2	H	BA	A	B	C	D	G	J
4.25	5.5	7	0.41	3.5	10.4	9.3	21.85	5.25	0.83	2.4

L	P	AA	AB	KEY	KEYSEAT	SHAFT	N-W	U
L	P	AA	AB	ES	S	R	N-W	U
13	12.2	1	11.4	2.44	0.312	1.201	3.38	1.375

ALL DIMENSIONS IN INCHES

REVISED - 09/16/16