

DATA SHEET

Premium Efficiency Motor: **ODP1-18-200-143T,**

60 Hz

WorldWide Electric Corporation

1 (800) 808-2131

Worldwideelectric.net



Document Generated: 12-Dec-2023
Document ID:

Customer:

MOTOR INFORMATION	
HP	1
RPM	1800
Phase	3
Frequency	60
Voltage	200
Frame Size	143/5T
Enclosure	ODP
Degree of Protection	IP23
Service Factor	1.15
Poles	4
Full Load Speed	1742
Insulation Class	F
Temp Rise	80°C
NEMA Code Letter	K
Duty Cycle	S1 / Continuous
Slip	3.20%
NEMA Design	B
Moment of Inertia	0.091 lb.ft.^2
Locked Rotor Time (Hot)	12 seconds
Sound Pressure Level	57 dB(A)
Number of Starts	2 Cold / 1 Hot
Max Ambient Temperature	40°C
Max Elevation	1000 m.a.s.l (3300 f.a.s.l)
Mounting	F1
Rotation	Bi-Directional
Area of Classification	Safe Area
Inverter Rating	10:1 CT / 20:1 VT
Standard	NEMA MG 1
Approvals	UL, CE

EFFICIENCY/POWER FACTOR		
LOAD	EFF	P. F.
100%	85.5 %	0.8
75%	86.2 %	0.73
50%	84.8 %	0.62

TORQUE		
FULL LOAD	LRT	BDT
3.03 lb.ft.	314 %	331 %

AMPERAGE INFORMATION	
	200V
Full Load Amps	3.22
Locked Rotor Amps	24.357A
No Load Current	1.61A

BEARING INFORMATION	
DE Bearing	6205ZZ
ODE Bearing	6204ZZ
Grease Type	NSK SN7
DE Regreasing Interval	-- Hours
ODE Regreasing Interval	-- Hours
Grease Quantity	--

ADDITIONAL DATA	
F2 Suitable	No
Shaft Material	AISI 1045
Connection Diagram	6 Lead Delta
Approximate Weight	33.1 lbs.

MOTOR DRAWING

Premium Efficiency Motor: **ODP1-18-200-143T**

WorldWide Electric Corporation

1 (800) 808-2131

Worldwideelectric.net

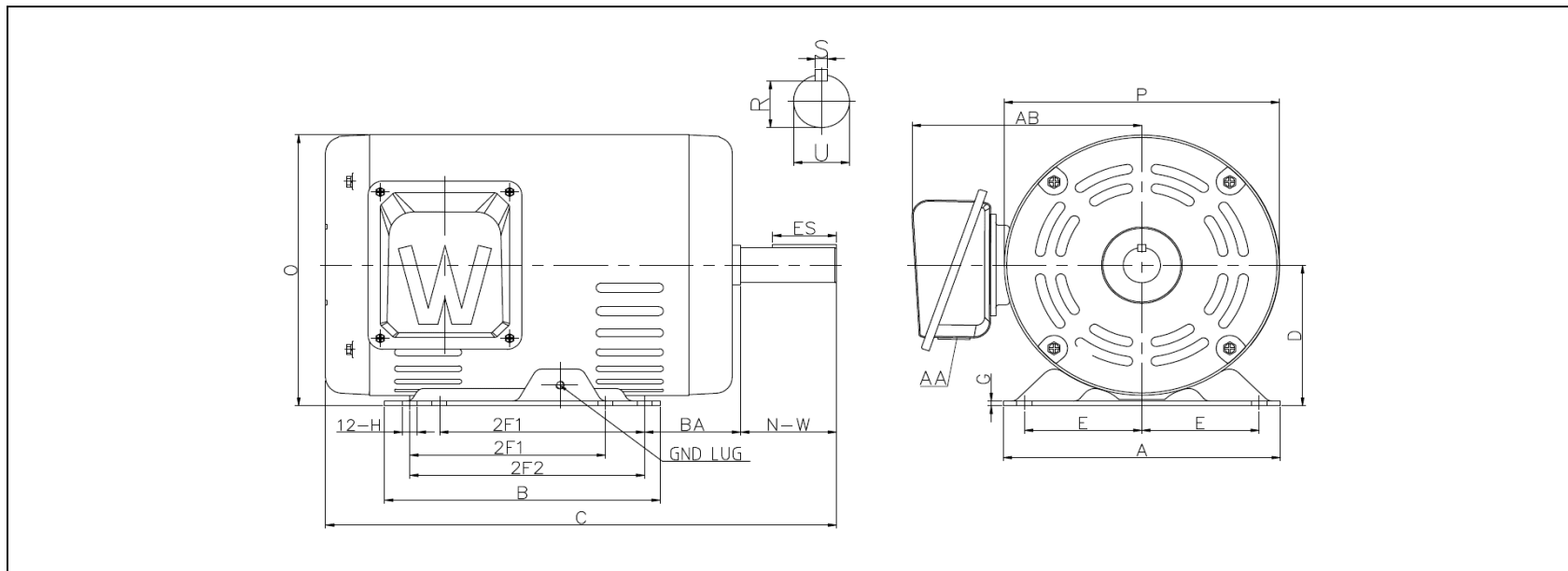

DIMENSION - INCHES

MOUNTING					A	B	C	D	G	P	O	T	AB
E	2F1	2F2	H	BA									
2.75	4	5	0.34	2.25	6.5	6.5	11.974	3.5	0.118	6.5	6.73	--	5.384

SHAFT & KEY				
S	ES	R	N-W	U
0.188	1.41	0.771	2.25	0.875

T-BOX	GND LUG
AA	
1.09	M5*P0.8

PERFORMANCE CURVES

Premium Efficiency Motor:

ODP1-18-200-143T

WorldWide Electric Corporation

1 (800) 808-2131

Worldwideelectric.net



Document Generated: 12-Dec-2023
Document ID:

Customer:

Motor Type	PEWWE		FL Speed	1742		
Output Rating (HP)	1		LRT (%FLT)	314	200 volt FLA	3.22
Full Load Torque	3.03	lb.ft	BDT (%FLT)	331		
Rotor Wk ²	0.091	lb-ft ²				

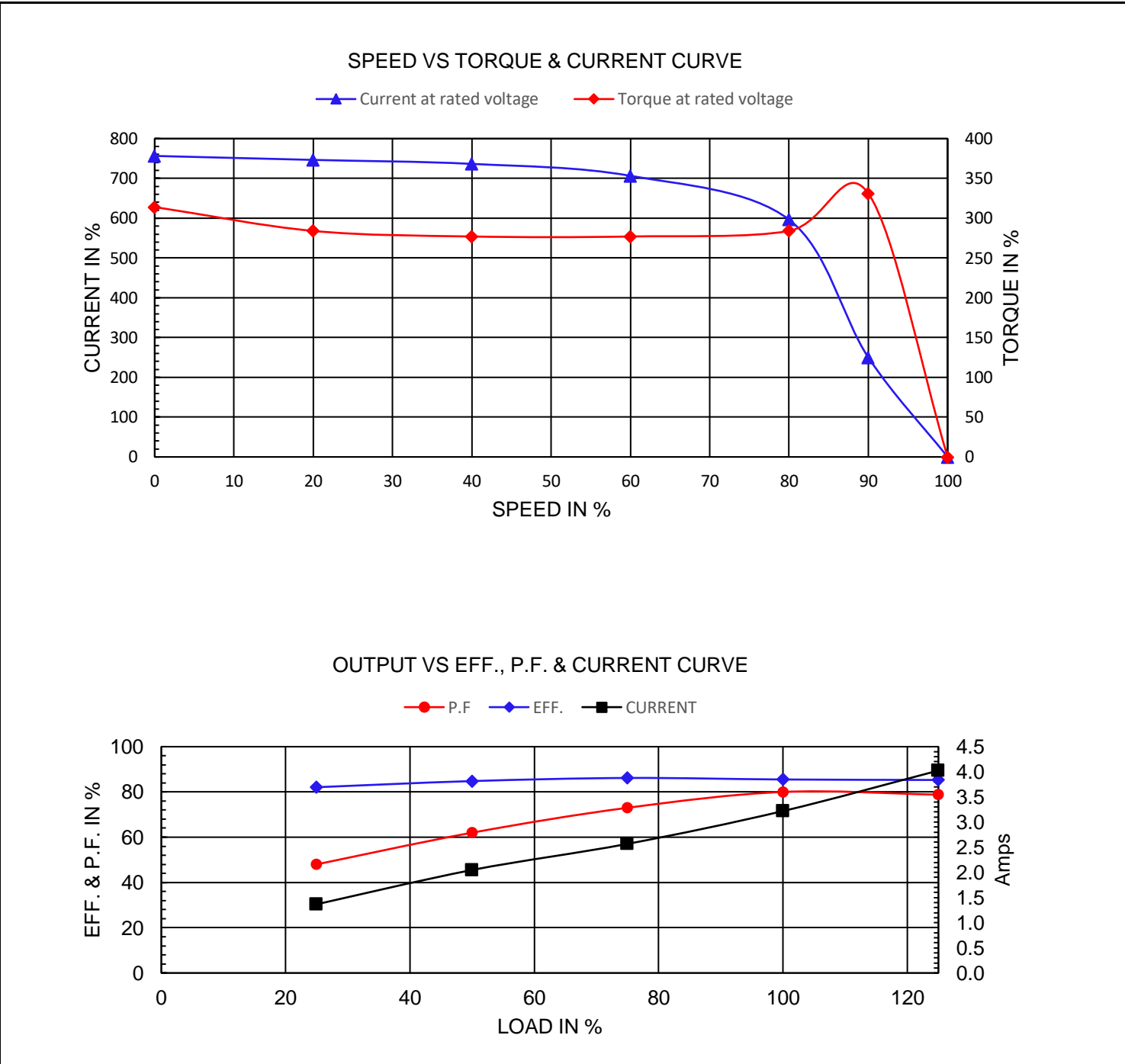

NAMEPLATE / WIRING

WorldWide Electric Corporation

1 (800) 808-2131

Worldwideelectric.net







Premium Efficiency Motor: **ODP1-18-200-143T**

Document Generated: 12-Dec-2023
Document ID:

Customer:

SAMPLE NAMEPLATE DATA

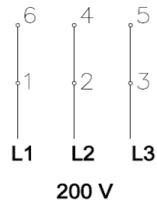
		OPEN DRIP PROOF 3 PHASE MOTOR									
Model :		Encl :		SN :							
HP :	Poles :	FR :	Ins :	IP 23	Max Amb 40°C	Duty : Cont					
Hz :				CODE:		Design :					
Volts :				P.F. :		DE BRG :					
Amps :				Eff :		ODE BRG :					
RPM :				S.F. :		WT :					
						Date :					
WorldWide Electric Corporation											

Model	ODP1-18-200-143T	Encl	ODP			
HP:	1	Poles:	4	FR:	143/5T	Ins: F
Hz:	60	Code:	K	Design	B	
Volts:	200	P.F.:	0.8	DE BRG:	6205ZZ	
Amps	3.22	Eff:	85.5%	ODE BRG:	6204ZZ	
RPM	1742	S.F. :	1.15	WT:	33.1 lbs.	