

DATA SHEET

Premium Efficiency Motor: **ODP10-18-200-215T,**

60 Hz

WorldWide Electric Corporation

1 (800) 808-2131

Worldwideelectric.net



Document Generated: 12-Dec-2023
Document ID:

Customer:

MOTOR INFORMATION	
HP	10
RPM	1800
Phase	3
Frequency	60
Voltage	200
Frame Size	213/5T
Enclosure	ODP
Degree of Protection	IP23
Service Factor	1.15
Poles	4
Full Load Speed	1757
Insulation Class	F
Temp Rise	80°C
NEMA Code Letter	H
Duty Cycle	S1 / Continuous
Slip	2.62%
NEMA Design	B
Moment of Inertia	1.221 lb.ft.^2
Locked Rotor Time (Hot)	12 seconds
Sound Pressure Level	62 dB(A)
Number of Starts	2 Cold / 1 Hot
Max Ambient Temperature	40°C
Max Elevation	1000 m.a.s.l (3300 f.a.s.l)
Mounting	F1
Rotation	Bi-Directional
Area of Classification	Safe Area
Inverter Rating	10:1 CT / 20:1 VT
Standard	NEMA MG 1
Approvals	UL, CE

EFFICIENCY/POWER FACTOR		
LOAD	EFF	P. F.
100%	91.7 %	0.81
75%	91.4 %	0.80
50%	90.6 %	0.7

TORQUE		
FULL LOAD	LRT	BDT
30.14 lb.ft.	323 %	334 %

AMPERAGE INFORMATION	
	200V
Full Load Amps	29.44
Locked Rotor Amps	184.92A
No Load Current	11.776A

BEARING INFORMATION	
DE Bearing	6308ZZ
ODE Bearing	6306ZZ
Grease Type	NSK SN7
DE Regreasing Interval	-- Hours
ODE Regreasing Interval	-- Hours
Grease Quantity	--

ADDITIONAL DATA	
F2 Suitable	No
Shaft Material	AISI 1045
Connection Diagram	6 Lead Delta
Approximate Weight	156 lbs.

MOTOR DRAWING

Premium Efficiency Motor: **ODP10-18-200-215T**

WorldWide Electric Corporation

1 (800) 808-2131

Worldwideelectric.net

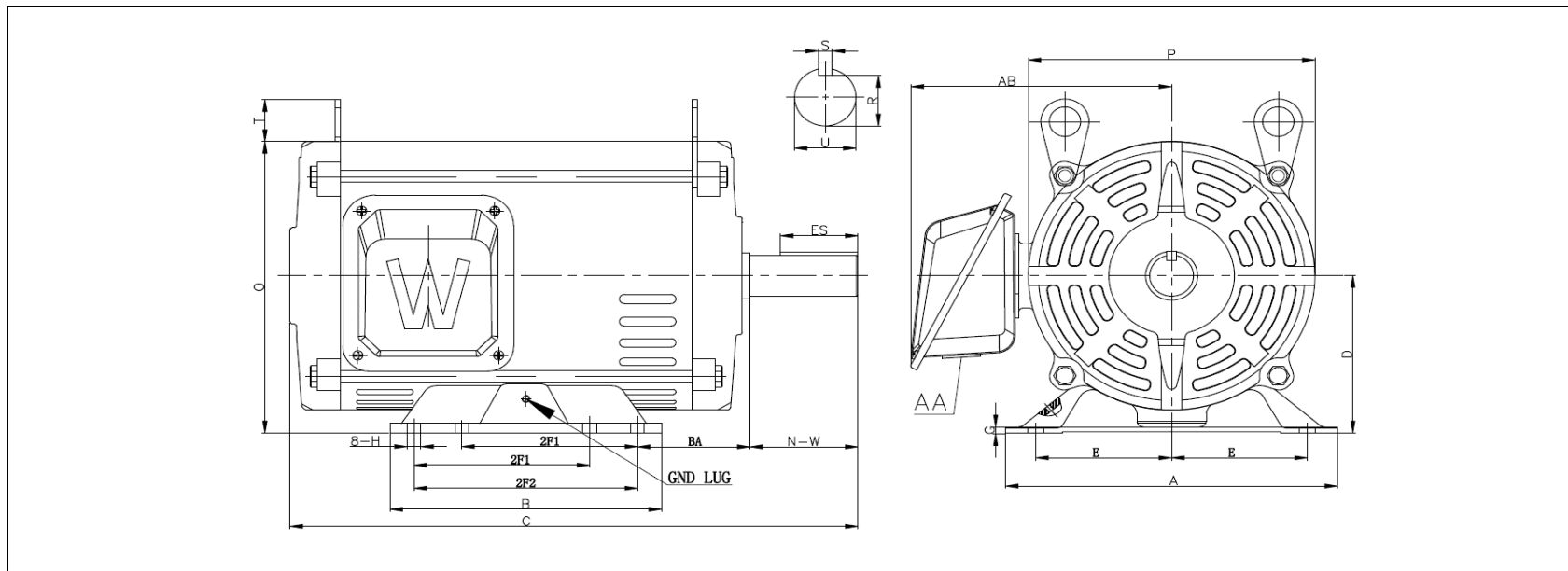

DIMENSION - INCHES

MOUNTING					A	B	C	D	G	P	O	T	AB
E	2F1	2F2	H	BA									
4.25	5.5	7	0.43	3.5	9.69	8.19	17.8	5.25	0.16	9.4	9.8	1.5	8.16

SHAFT & KEY				
S	ES	R	N-W	U
0.31	2.41	1.201	3.38	1.375

T-BOX	GND LUG
AA	M6*P1.0
1.38	

PERFORMANCE CURVES

Premium Efficiency Motor:

ODP10-18-200-215T

WorldWide Electric Corporation

1 (800) 808-2131

Worldwideelectric.net



Document Generated: 12-Dec-2023
Document ID:

Customer:

Motor Type	PEWWE		FL Speed	1757	
Output Rating (HP)	10		LRT (%FLT)	323	
Full Load Torque	30.14	lb.ft	200 volt FLA	29.44	
Rotor Wk ²	1.221	lb-ft ²	BDT (%FLT)	334	

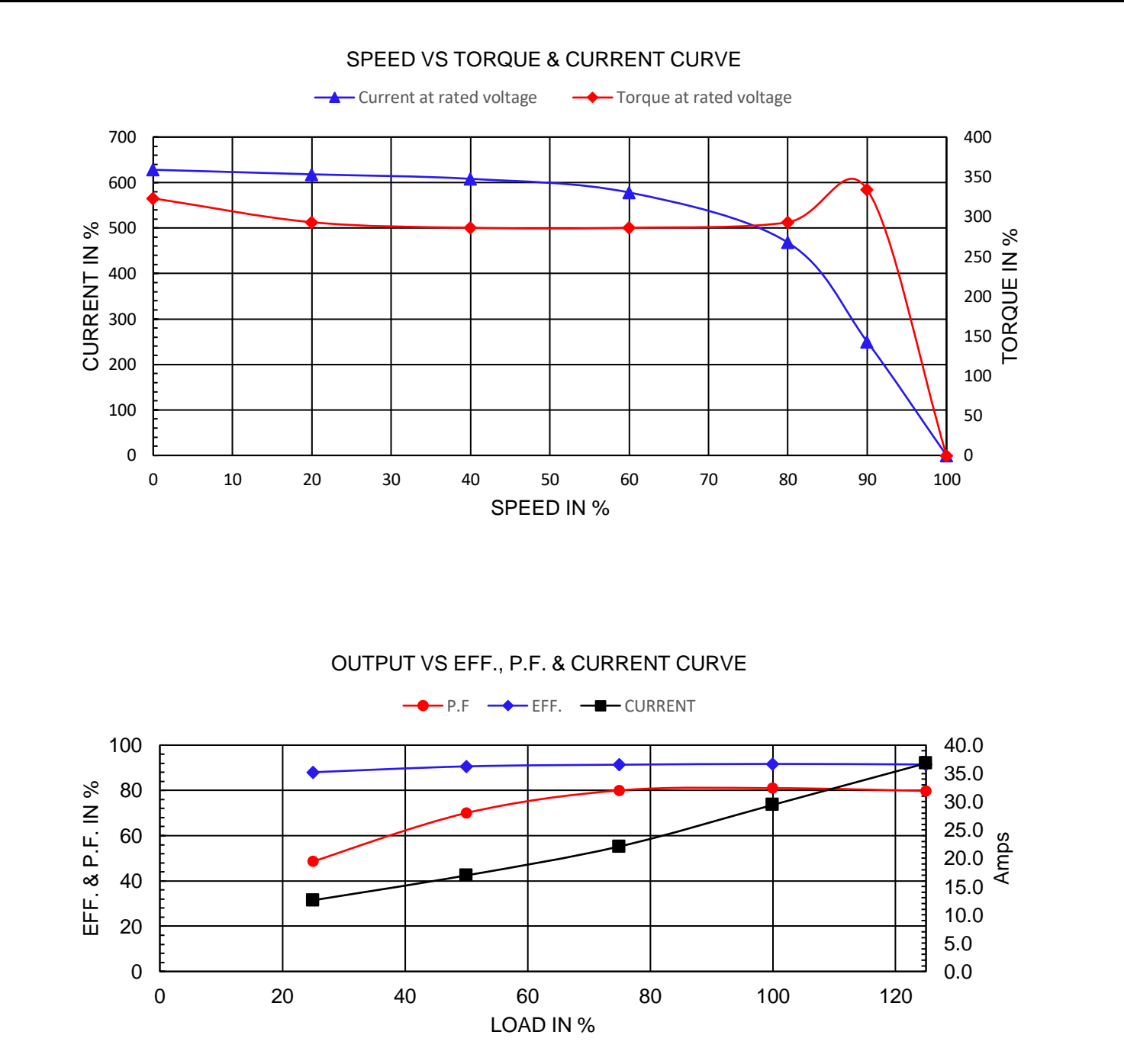

NAMEPLATE / WIRING

WorldWide Electric Corporation

1 (800) 808-2131

Worldwideelectric.net







Premium Efficiency Motor: **ODP10-18-200-215T**

Document Generated: 12-Dec-2023
Document ID:

Customer:

SAMPLE NAMEPLATE DATA

		OPEN DRIP PROOF 3 PHASE MOTOR									
Model :		Encl :		SN :							
HP :	Poles :	FR :	Ins : F	IP 23	Max Amb 40°C	Duty:Cont					
Hz :	CODE:			Design :							
Volts :	P.F. :			DE BRG :							
Amps :	Eff :			ODE BRG :							
RPM :	S.F. :			WT :							
										Date :	
WorldWide Electric Corporation											

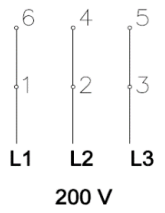

Model	ODP10-18-200-215T	Encl	ODP				
HP:	10	Poles:	4	FR:	213/5T	Ins:	F
Hz:	60	Code:	H	Design	B		
Volts:	200	P.F.:	0.81	DE BRG:	6308ZZ		
Amps	29.44	Eff:	91.7%	ODE BRG:	6306ZZ		
RPM	1757	S.F. :	1.15	WT:	156 lbs.		