

DATA SHEET

Premium Efficiency Motor: **ODP10-36-213T,**

60 Hz

WorldWide Electric Corporation

1 (800) 808-2131

Worldwideelectric.net



Document Generated: 8-Dec-2023
Document ID:

Customer:

MOTOR INFORMATION	
HP	10
RPM	3600
Phase	3
Frequency	60
Voltage	230/460
Frame Size	213/5T
Enclosure	ODP
Degree of Protection	IP23
Service Factor	1.15
Poles	2
Full Load Speed	3494
Insulation Class	F
Temp Rise	80°C
NEMA Code Letter	H
Duty Cycle	S1 / Continuous
Slip	2.93%
NEMA Design	B
Moment of Inertia	0.542 lb.ft.^2
Locked Rotor Time (Hot)	12 seconds
Sound Pressure Level	64 dB(A)
Number of Starts	2 Cold / 1 Hot
Max Ambient Temperature	40°C
Max Elevation	1000 m.a.s.l (3300 f.a.s.l)
Mounting	F1
Rotation	Bi-Directional
Area of Classification	Safe Area
Inverter Rating	10:1 CT / 20:1 VT
Standard	NEMA MG 1
Approvals	UL, CE

EFFICIENCY/POWER FACTOR		
LOAD	EFF	P. F.
100%	89.5 %	0.89
75%	90.9 %	0.88
50%	91.1 %	0.84

TORQUE		
FULL LOAD	LRT	BDT
15.11 lb.ft.	360 %	312 %

AMPERAGE INFORMATION		
	230V	460V
Full Load Amps	23.6A	11.8A
Locked Rotor Amps	162.88A	81.44A
No Load Current	5.1A	2.55A
Usable at 208V	13.05A	

BEARING INFORMATION	
DE Bearing	6308ZZ
ODE Bearing	6306ZZ
Grease Type	NSK SN7
DE Regreasing Interval	-- Hours
ODE Regreasing Interval	-- Hours
Grease Quantity	--

ADDITIONAL DATA	
F2 Suitable	No
Shaft Material	AISI 1045
Connection Diagram	9 Lead Wye
Approximate Weight	150.4 lbs.

MOTOR DRAWING

Premium Efficiency Motor: **ODP10-36-213T**

WorldWide Electric Corporation

1 (800) 808-2131

Worldwideelectric.net

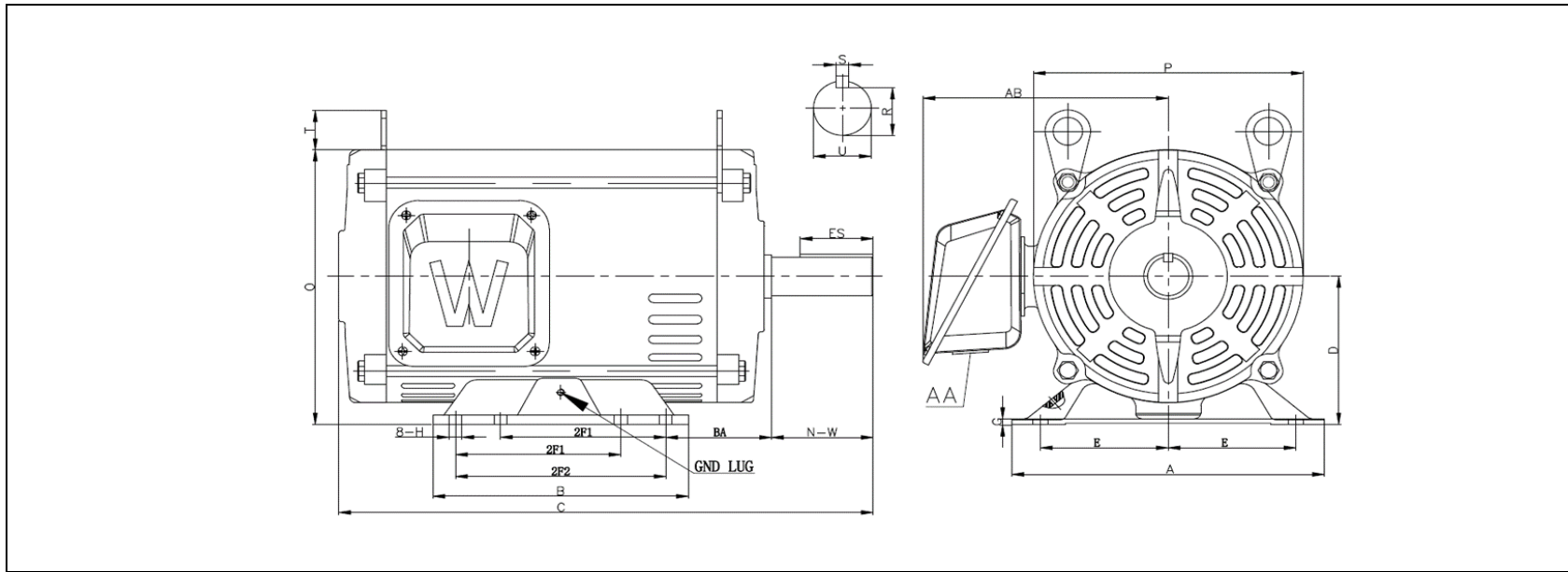

DIMENSION - INCHES

MOUNTING					A	B	C	D	G	P	O	T	AB
E	2F1	2F2	H	BA									
4.25	5.5	7	0.43	3.5	9.69	8.19	17.8	5.25	0.16	9.4	9.8	1.5	8.16

SHAFT & KEY				
S	ES	R	N-W	U
0.31	2.41	1.201	3.38	1.375

T-BOX	GND LUG
AA	
1.38	M6*P1.0

PERFORMANCE CURVES

WorldWide Electric Corporation

1 (800) 808-2131

Worldwideelectric.net



Premium Efficiency Motor:

ODP10-36-213T

Document Generated: 8-Dec-2023	Customer:
Document ID:	

Motor Type	ODP				
Output Rating (HP)	10	FL Speed	3494		
Full Load Torque	15.11 lb.ft	LRT (%FLT)	360	460 volt FLA	11.8
Rotor Wk ²	0.895 lb-ft ²	BDT (%FLT)	312	230 volt FLA	23.6

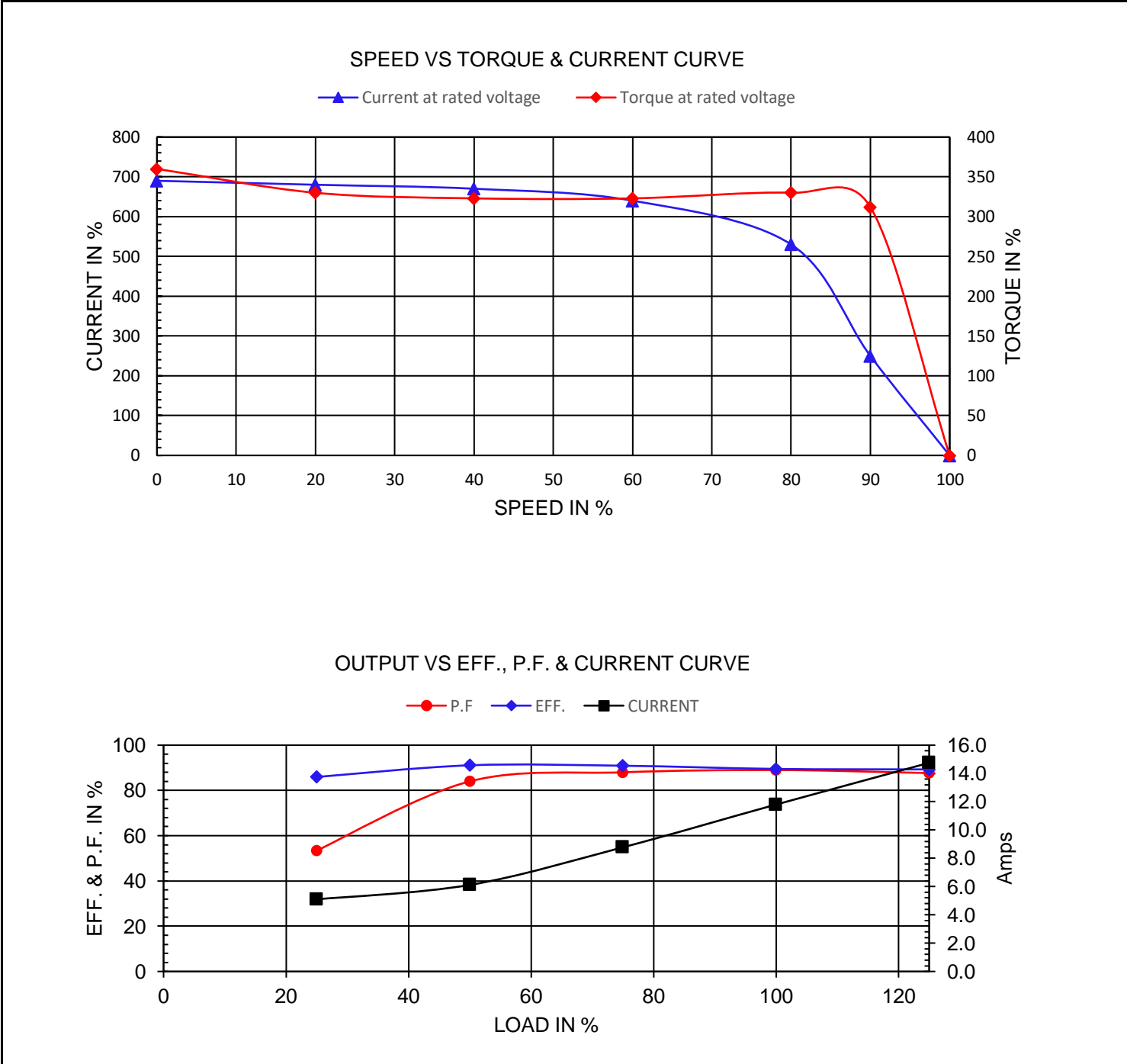

NAMEPLATE / WIRING

WorldWide Electric Corporation

1 (800) 808-2131

Worldwideelectric.net







Premium Efficiency Motor: **ODP10-36-213T**

Document Generated: 8-Dec-2023
Document ID:

Customer:

SAMPLE NAMEPLATE DATA

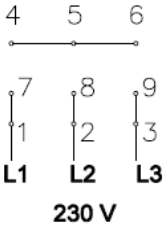
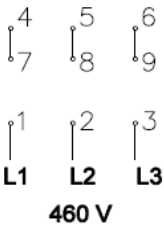
		OPEN DRIP PROOF 3 PHASE MOTOR						
Model :		Encl : ODP		SN :				
HP :	Poles :	FR :	Ins : F	IP 23	Max Amb 40°C	Duty : Cont		
Hz : 60	CODE:	Hz : 50	Design : B					
Volts : 230/460	P.F. :	Volts : 190/380	DE BRG :					
Amps :	Eff: %	Amps :	ODE BRG :					
RPM :	S.F. : 1.15	RPM :	WT: LBS					
				S.F. :	Date :			
WorldWide Electric Corporation								

Model: ODP10-36-213T		Encl: ODP					
HP: 10	Poles: 2	Frame 213/5T	Ins Cl: F	IP IP23			
Hz: 60	Code: H	Hz: 50	Design: B				
Volts: 230/460	P.F.: 0.89	Volts: 190/380	DE Brg: 6308ZZ				
Amps: 23.6/11.8	Eff: 89.5%	Amps: 27/13.5	ODE Brg: 6306ZZ				
RPM: 3494	S.F.: 1.15	RPM: 2906	WT: 150.4 lbs.				
		S.F.: 1.0					