

DATA SHEET

Premium Efficiency Motor: **ODP3-18-182TC,**

60 Hz

WorldWide Electric Corporation

1 (800) 808-2131

Worldwideelectric.net



Document Generated: 11-Dec-2023
Document ID:

Customer:

MOTOR INFORMATION	
HP	3
RPM	1800
Phase	3
Frequency	60
Voltage	230/460
Frame Size	182/4TC
Enclosure	ODP
Degree of Protection	IP23
Service Factor	1.15
Poles	4
Full Load Speed	1753
Insulation Class	F
Temp Rise	80°C
NEMA Code Letter	K
Duty Cycle	S1 / Continuous
Slip	2.59%
NEMA Design	B
Moment of Inertia	0.337 lb.ft.^2
Locked Rotor Time (Hot)	12 seconds
Sound Pressure Level	60 dB(A)
Number of Starts	2 Cold / 1 Hot
Max Ambient Temperature	40°C
Max Elevation	1000 m.a.s.l (3300 f.a.s.l)
Mounting	F1
Rotation	Bi-Directional
Area of Classification	Safe Area
Inverter Rating	10:1 CT / 20:1 VT
Standard	NEMA MG 1
Approvals	UL, CE

EFFICIENCY/POWER FACTOR		
LOAD	EFF	P. F.
100%	89.5 %	0.8
75%	89.6 %	0.73
50%	88.1 %	0.62

TORQUE		
FULL LOAD	LRT	BDT
8.8 lb.ft.	345 %	360 %

AMPERAGE INFORMATION		
	230V	460V
Full Load Amps	7.8A	3.9A
Locked Rotor Amps	63.64A	31.82A
No Load Current	3.74A	1.87A
Usable at 208V	4.31A	

BEARING INFORMATION	
DE Bearing	6306ZZ
ODE Bearing	6305ZZ
Grease Type	NSK SN7
DE Regreasing Interval	-- Hours
ODE Regreasing Interval	-- Hours
Grease Quantity	--

ADDITIONAL DATA	
F2 Suitable	No
Shaft Material	AISI 1045
Connection Diagram	9 Lead Wye
Approximate Weight	68.3 lbs.

MOTOR DRAWING

Premium Efficiency Motor: **ODP3-18-182TC**

WorldWide Electric Corporation

1 (800) 808-2131

Worldwideelectric.net

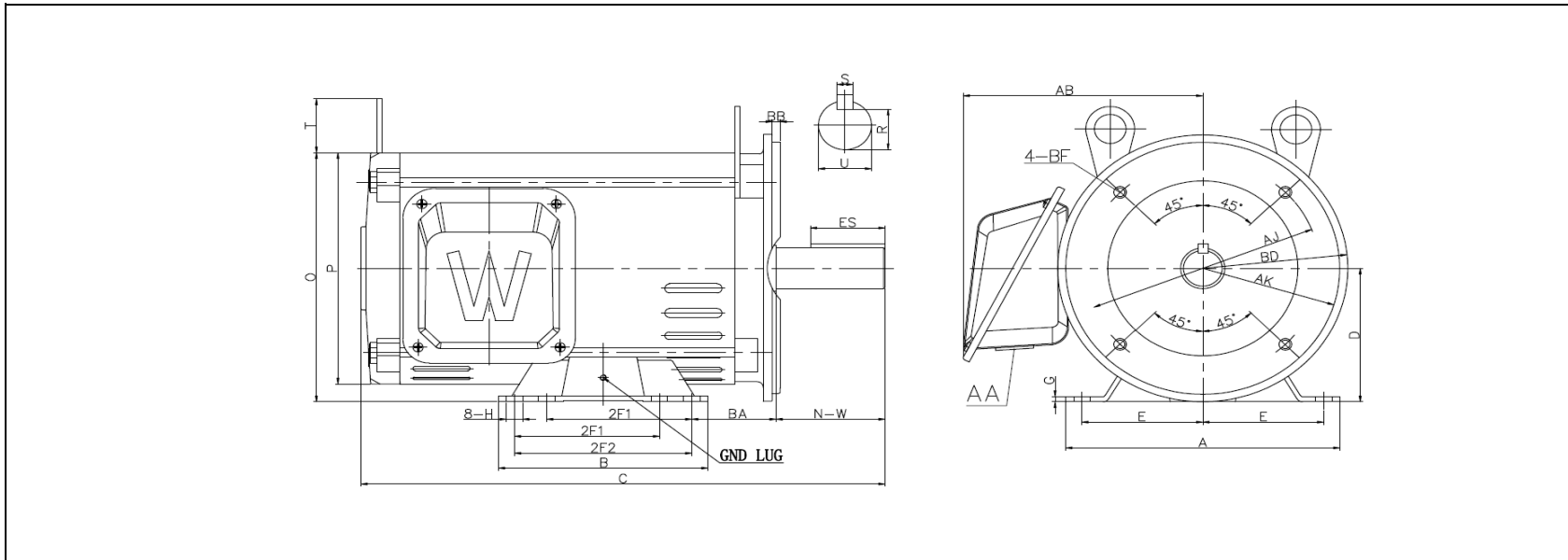

DIMENSION - INCHES

MOUNTING					A	B	C	D	G	P	O	T	AB
E	2F1	2F2	H	BA									
3.75	4.5	5.5	0.41	2.75	8.5	6.495	16.4	4.5	0.41	7.72	8.36	1.6	7.55

SHAFT & KEY				
S	ES	R	N-W	U
0.25	1.78	0.986	2.75	1.125

T-BOX	GND LUG
AA	
1.09	M5*P0.8

FLANGE				
AK	BD	AJ	BF	BB
8.5	9	7.25	4*1/2-13 UNC	0.25

PERFORMANCE CURVES

Premium Efficiency Motor:

ODP3-18-182TC

WorldWide Electric Corporation

1 (800) 808-2131

Worldwideelectric.net



Document Generated: 11-Dec-2023
Document ID:

Customer:

Motor Type	ODP		FL Speed	1753	
Output Rating (HP)	3		LRT (%FLT)	345	460 volt FLA 3.9
Full Load Torque	8.8	lb.ft	BDT (%FLT)	360	230 volt FLA 7.8
Rotor Wk ²	0.895	lb-ft ²			

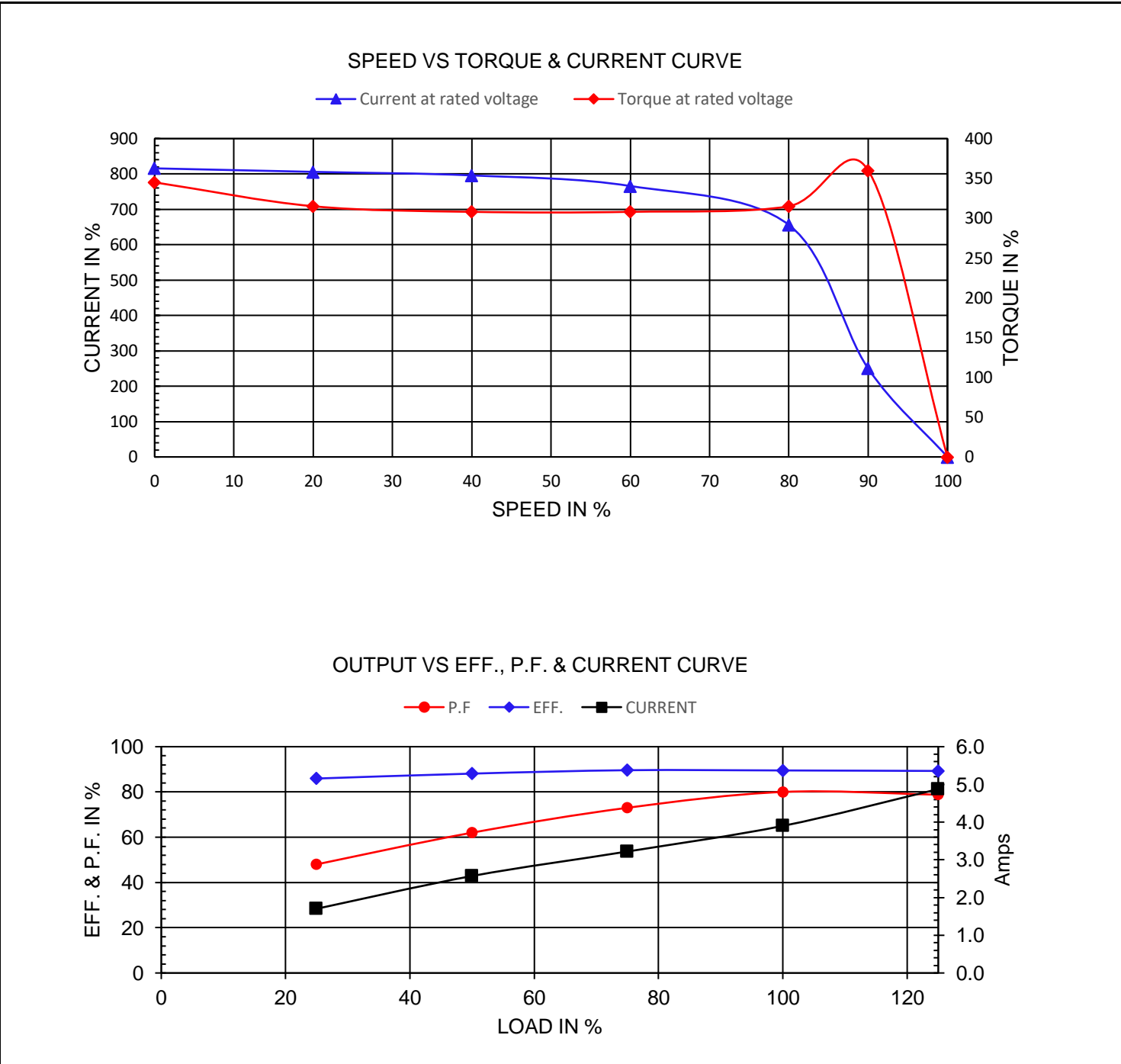

NAMEPLATE / WIRING

WorldWide Electric Corporation

1 (800) 808-2131

Worldwideelectric.net







Premium Efficiency Motor: **ODP3-18-182TC**

Document Generated: 11-Dec-2023
Document ID:

Customer:

SAMPLE NAMEPLATE DATA

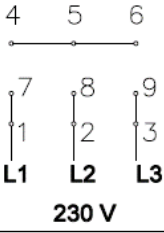
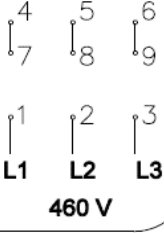
		OPEN DRIP PROOF 3 PHASE MOTOR									
Model :		Encl : ODP		SN :							
HP :	Poles :	FR :	Ins : F	IP 23	Max Amb 40°C	Duty : Cont					
Hz : 60	CODE:		Hz : 50		Design : B						
Volts : 230/460	P.F. :		Volts : 190/380		DE BRG :						
Amps :	Eff : %		Amps :		ODE BRG :						
RPM :	S.F. : 1.15		RPM :		WT : LBS						
		S.F. :		S.F. :		Date :					
WorldWide Electric Corporation											

Model: ODP3-18-182TC		Encl: ODP									
HP: 3	Poles: 4	Frame	182/4TC	Ins Cl:	F	IP	IP23				
Hz: 60	Code: K	Hz:	50	Design:	B						
Volts: 230/460	P.F.: 0.8	Volts:	190/380	DE Brg:	6306ZZ						
Amps: 7.8/3.9	Eff: 89.5%	Amps:	9.4/4.7	ODE Brg:	6305ZZ						
RPM: 1753	S.F.: 1.15	RPM:	1437	WT:	68.3 lbs.						
		S.F.:	1.0								