

DATA SHEET

Premium Efficiency Motor: **ODPJ2-36-56CB**

60 Hz

WorldWide Electric Corporation

1 (800) 808-2131

Worldwideelectric.net



Document Generated: 5-May-2022

Document ID:

Customer:

MOTOR INFORMATION

HP	2
RPM	3600
Phase	3
Frequency	60
Voltage	230/460
Frame Size	56C
Enclosure	ODP
Degree of Protection	IP23
Service Factor	1.20
Poles	2
Full Load Speed	3510
Insulation Class	F
Temp Rise	80°C
NEMA Code Letter	K
Duty Cycle	S1 / Continuous
Slip	2.54%
NEMA Design	B
Moment of Inertia	0.062150353125 lb.ft.^2
Locked Rotor Time (Hot)	12 seconds
Sound Pressure Level	78 dB(A)
Number of Starts/Hour (Hot)	2
Max Ambient Temperature	40°C
Max Elevation	3300 FASL
Mounting	F1
Rotation	Bi-Directional
Area of Classification	Safe
Inverter Rating	N/A
Standard	NEMA
Approvals	UL

EFFICIENCY/POWER FACTOR

LOAD	EFF	P. F.
100%	85.5 %	0.86
75%	87.1 %	0.81
50%	85.1 %	0.71

TORQUE

FULL LOAD	LRT	BDT
2.99 lb.ft.	325 %	364 %

AMPERAGE INFORMATION

	230V	460V
Full Load Amps	5.002A	2.501A
Locked Rotor Amps	44.72A	22.36A
No Load Current	2.14A	1.07A
Usable at 208V	5.5 A	

BEARING INFORMATION

DE Bearing	6203-ZZ
ODE Bearing	6203-ZZ
Grease Type	NS7 ENS
DE Regreasing Interval	-- Hours
ODE Regreasing Interval	-- Hours
Grease Quantity	--

ADDITIONAL DATA

F2 Suitable	No
Shaft Material	S45C+SUS304
Connection Diagram	9 Lead Wye
Approximate Weight	34.2 lbs.

ODP Jet Pump Motor Drawing

56CB

WorldWide Electric Corporation
 1 (800) 808-2131
 Worldwideelectric.net

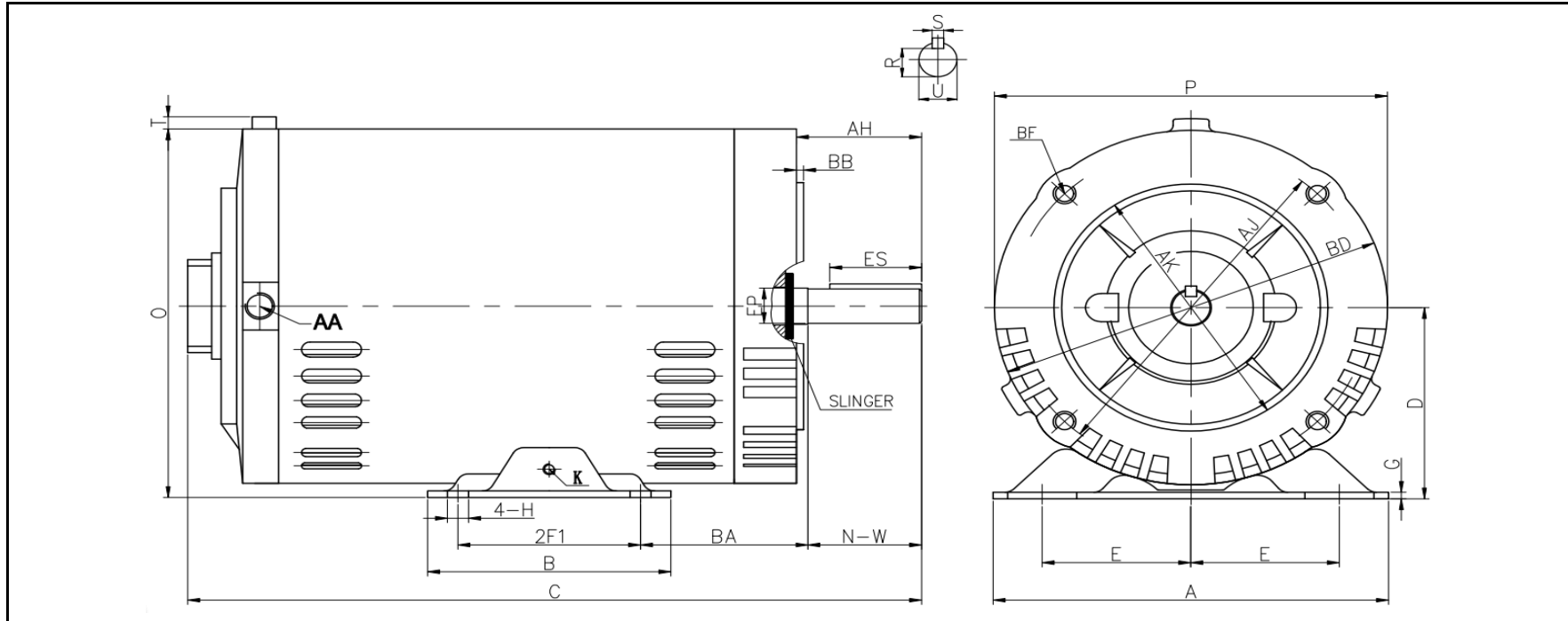

DIMENSIONS - INCHES

MOUNTING				A	B	C	D	G	P	O	T	Ground Lug K	AA
E	2F1	H	BA										
2.44	3	0.34	2.75	6.3	4	12.1	3.5	0.08	6.5	6.7	0.23	M5	1/2 NPT

SHAFT & KEY						
EP	S	ES	R	N-W	U	AH
0.66	0.188	1.41	0.517	1.88	0.625	2.06

FLANGE				
AK	BD	AJ	BF	BB
4.5	6.5	5.875	4*3/8-16 UNC	0.16

NAMEPLATE / WIRING

WorldWide Electric Corporation

1 (800) 808-2131

Worldwideelectric.net



Premium Efficiency Motor: **ODPJ2-36-56CB**

Document Generated: 5-May-2022
Document ID:

Customer:

SAMPLE NAMEPLATE DATA

		OPEN DRIP PROOF THREE PHASE JET PUMP MOTOR						
Model :		Encl : ODP		SN :			4 5 6 	
HP :	Poles : 2	FR :	Ins : F	IP 23	Max Amb 40°C	Duty : Cont	7 8 9 1 2 3 L1 L2 L3 208-230 V	
Hz : 60	CODE:			Design :		4 5 6 7 8 9 L1 L2 L3 460 V		
Volts :	P.F. :			DE BRG :		ODE BRG :		
Amps :	Eff :			WT : LBS		Date :		
RPM :	S.F. :			S.F.A :		Usable on 208V 60Hz network at ___ Amps		
WorldWide Electric Corporation								

Model	ODPJ2-36-56CB	FR:	56C	Design:	B
HP:	2	CODE:	K	DE BRG:	6203-ZZ
Volts:	230/460V	P.F.:	0.86	ODE BRG:	6203-ZZ
Amps:	5.00/2.50A	Eff:	85.5%	WT:	34.2 lbs.
RPM:	3510	S.F.:	1.2	S.F.A:	2.946A
		S.F.A:	2.946A		
	Usable on 208V 60Hz Network at		5.5 A		