

DATA SHEET

Premium Efficiency Motor: **PEWWE250-12-449T-IB**

60 Hz

WorldWide Electric Corporation

1 (800) 808-2131

Worldwideelectric.net



Document Generated: 31-Jul-2023

Document ID:

Customer:

MOTOR INFORMATION

HP	250
RPM	1200
Phase	3
Frequency	60 Hz
Voltage	460 V
Frame Size	449T
Enclosure	TEFC
Degree of Protection	IP55
Service Factor	1.15
Poles	6
Full Load Speed	1190
Insulation Class	F
Temp Rise	80°C
NEMA Code Letter	G
Duty Cycle	S1 / Continuous
Slip	0.83%
NEMA Design	B
Moment of Inertia	131 lb.ft.^2
Locked Rotor Time (Hot)	16 seconds
Sound Pressure Level	78 dB(A)
Number of Starts	2 Cold/ 1 Hot
Max Ambient Temperature	40°C
Max Elevation	1000 m.a.s.l (3300 f.a.s.l)
Mounting	F1
Rotation	Bi-Directional
Area of Classification	Class 1 Division 2 Groups A,B,C,D T3(200°C)
Inverter Rating	10:1 CT / 20:1 VT PWM Type
Standard	NEMA MG-1
Approvals	CSA-US, CE

EFFICIENCY/POWER FACTOR

LOAD	EFF	P. F.
100%	95.8 %	0.81
75%	95.8 %	0.76
50%	95.4 %	0.66

TORQUE

FULL LOAD	LRT	BDT
1103 lb.ft.	190 %	250 %

AMPERAGE INFORMATION

	230V	460V
Full Load Amps	--A	302A
Locked Rotor Amps	--A	1825A
No Load Current	--A	125A
Usable at 208V	--A	

BEARING INFORMATION

DE Bearing	NU320 C3
ODE Bearing	6320 M/C3
Grease Type	SKF LGHP 2
DE Regreasing Interval	2000 Hours
ODE Regreasing Interval	2700 Hours

ADDITIONAL DATA

F2 Suitable	Yes
Shaft Material	4140 Carbon Steel
Connection Diagram	460 V - 6 Lead Δ
Approximate Weight	2886 lbs.

MOTOR DRAWING

Premium Efficiency Motor: **PEWWE250-12-449T-IB**

WorldWide Electric Corporation

1 (800) 808-2131

Worldwideelectric.net

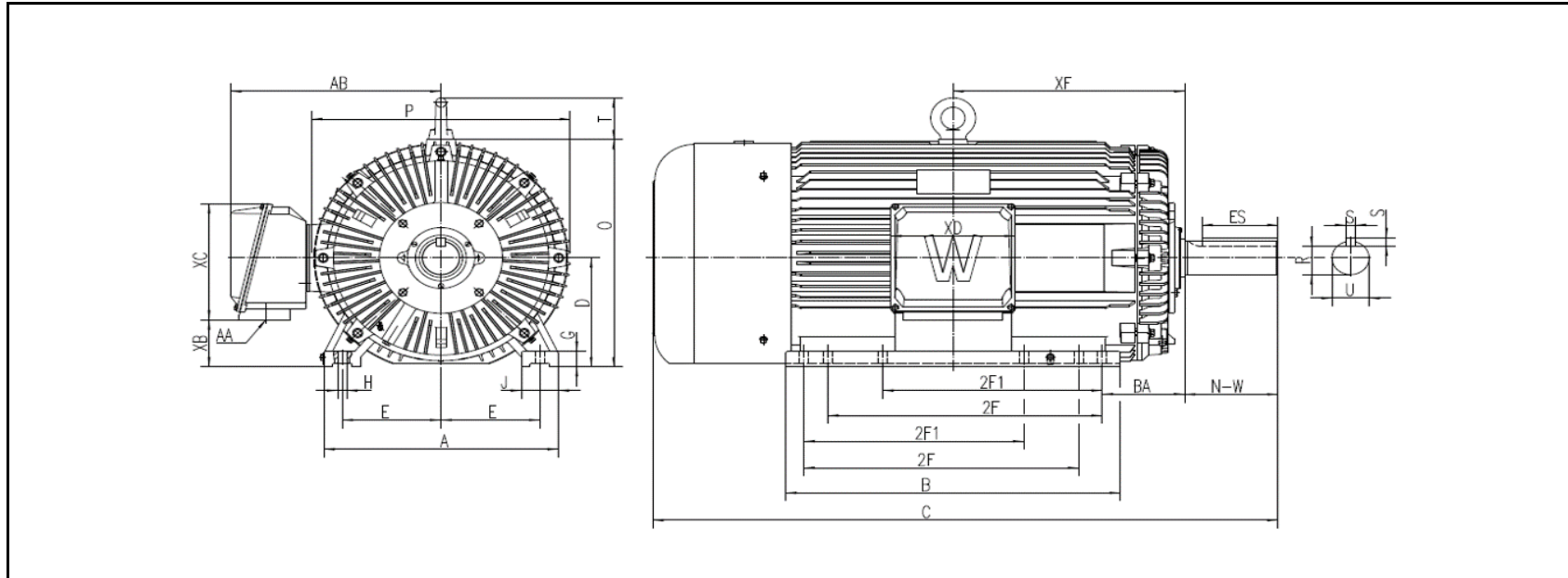

DIMENSION - INCHES

MOUNTING					A	B	C	D	G	J	P	O	T	AB
E	2F1	2F	H	BA										
9	20	25	0.81	7.5	21.339	30.472	56.945	11	1.575	3.346	23.554	22.969	4.213	19.171

SHAFT & KEY				
S	ES	R	N-W	U
0.875	6.91	2.88	8.5	3.375

TERMINAL BOX				
AA	XB	XC	XD	XF
2 X 3	4.7	11.813	11.339	21.087

PERFORMANCE CURVES

WorldWide Electric Corporation

1 (800) 808-2131

Worldwideelectric.net



Premium Efficiency Motor:

PEWWE250-12-449T-IB

Document Generated: 31-Jul-2023
 Document ID:

Customer:

Motor Type	PEWWE		FL Speed	1190	
Output Rating (HP)	250		LRT (%FLT)	190	460 volt FLA 302 A
Full Load Torque	1103 lb.ft		BDT (%FLT)	250	230 volt FLA -- A
Rotor Wk^2	131 lb-ft^2				

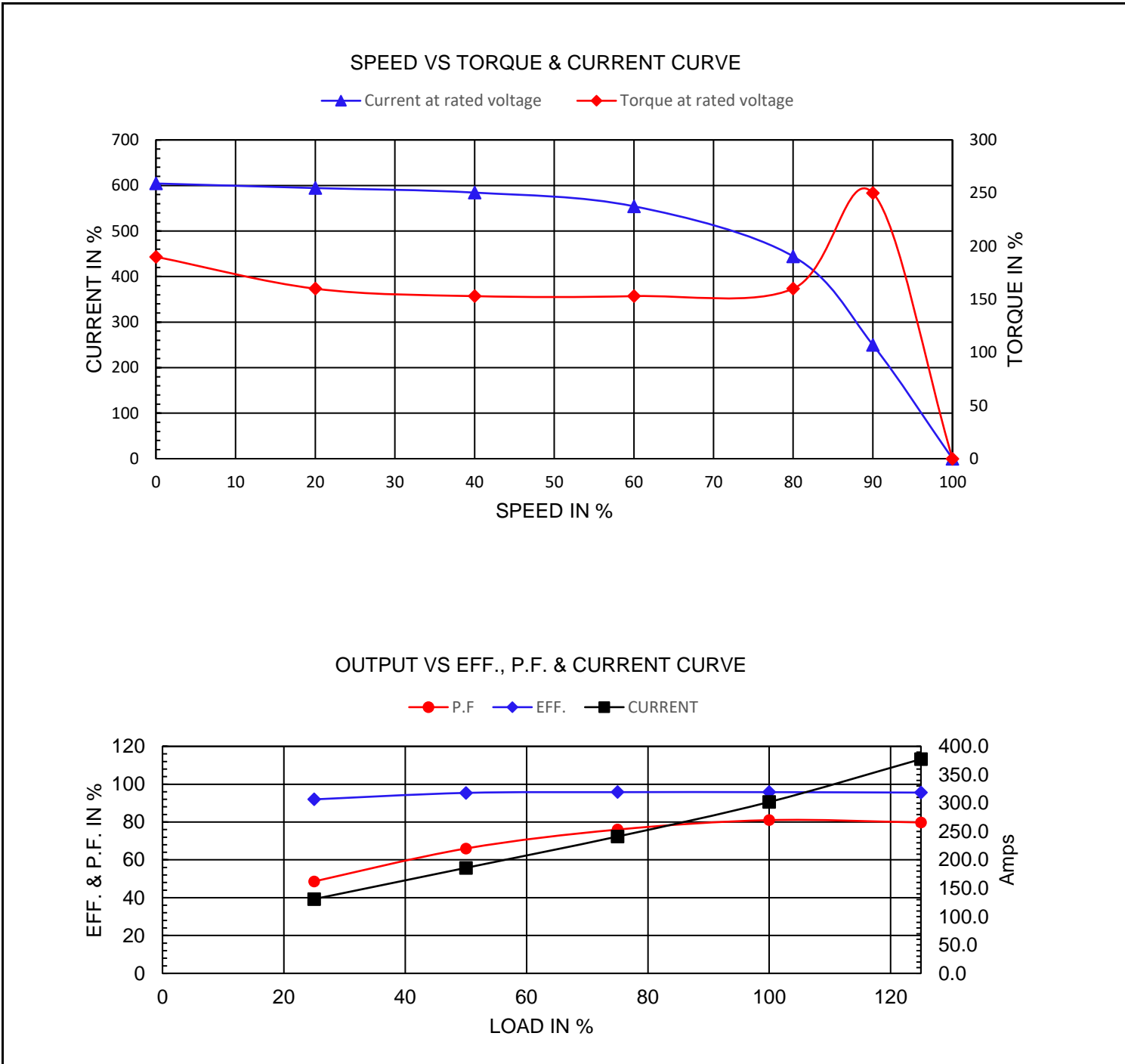

NAMEPLATE / WIRING

WorldWide Electric Corporation

1 (800) 808-2131

Worldwideelectric.net



Premium Efficiency Motor:

PEWWE250-12-449T-IB

Document Generated: 31-Jul-2023
Document ID:

Customer:

SAMPLE NAMEPLATE DATA

		NEMA Premium		3-PHASE INDUCTION MOTOR		259277			
Model		Ser No.		Connection					
HP		S.F.		IP		Encl			
Frame		P.F.		Code		Type			
Voltage		Hz		Ins Cl		Rating	°C Amb Cont		
Amps		RPM		Design		Date			
Nom.Eff.	FL	% 3/4	%	V	10:1 CT	20:1 VT	PWM	VFD 1.0SF	
Class I DIV. 2 Groups A B C D				Amb.40°C					
DE Brng				Grease type: LGHP 2					
ODE Brng				(compatible with polyrex)					
WorldWide Electric Corporation									

Model	PEWWE250-12-449T-IB								
HP	250	S.F.	1.15	IP	IP55	Encl	TEFC		
Frame	449T	P.F.	0.81	Code	G	Type			
Voltage	460 V	Hz	60 Hz	Ins Cl	F	Ambient	40°C		
Amps	302	RPM	1190	Design	B	DE Brng NU320 C3			
Nom.Eff.	FL	95.8%	3/4	95.8%	ODE Brng 6320 M/C3				
Class 1 Division 2 Groups A,B,C,D						T3(200°C)		Grease type: SKF LGHP 2	
50Hz	--	HP	--	--	A	-- rpm			