

DATA SHEET

Premium Efficiency Motor: **SSPENV1.5-36-143TCRD,**

60 Hz

WorldWide Electric Corporation

1 (800) 808-2131

Worldwideelectric.net



Document Generated: 22-Feb-2023
Document ID:

Customer:

MOTOR INFORMATION	
HP	1.5
RPM	3600
Phase	3
Frequency	60
Voltage	230/460
Frame Size	143TC
Enclosure	TENV
Degree of Protection	IP69K
Service Factor	1.15
Poles	2
Full Load Speed	3525
Insulation Class	F
Temp Rise	80°C
NEMA Code Letter	M
Duty Cycle	S1
Slip	2.08%
NEMA Design	B
Moment of Inertia	0.094 lb.ft.^2
Locked Rotor Time (Hot)	12 seconds
Sound Pressure Level	74 dB(A)
Number of Starts	10
Max Ambient Temperature	40° C
Max Elevation	1000 m.a.s.l (3300 f.a.s.l)
Mounting	F1
Rotation	Bidirectional
Area of Classification	Div.2 Class I, Gr. A,B,C&D T2B
Inverter Rating	10:1 CT/20:1 VT
Standard	NEMA MG1, UL1004
Approvals	CSA,UL,CE

EFFICIENCY/POWER FACTOR		
LOAD	EFF	P. F.
100%	84.0 %	0.89
75%	84.5 %	0.85
50%	83.0 %	0.75

TORQUE		
FULL LOAD	LRT	BDT
2.3 lb.ft.	285 %	300 %

AMPERAGE INFORMATION		
	230V	460V
Full Load Amps	3.7	1.85
Locked Rotor Amps	40	20
No Load Current	1.4	0.7
Usable at 208V		4

BEARING INFORMATION	
DE Bearing	6205 2RS
ODE Bearing	6205 2RS
Grease Type	Mobil Polyrex EM

ADDITIONAL DATA	
F2 Suitable	No
Shaft Material	304 Stainless Steel
Connection Diagram	9 Lead 2Y/Y
Approximate Weight	46 lbs.

WORLDWIDE ELECTRIC MOTOR DRAWING

SSPENV-143TCRD (1.5HP 2P)

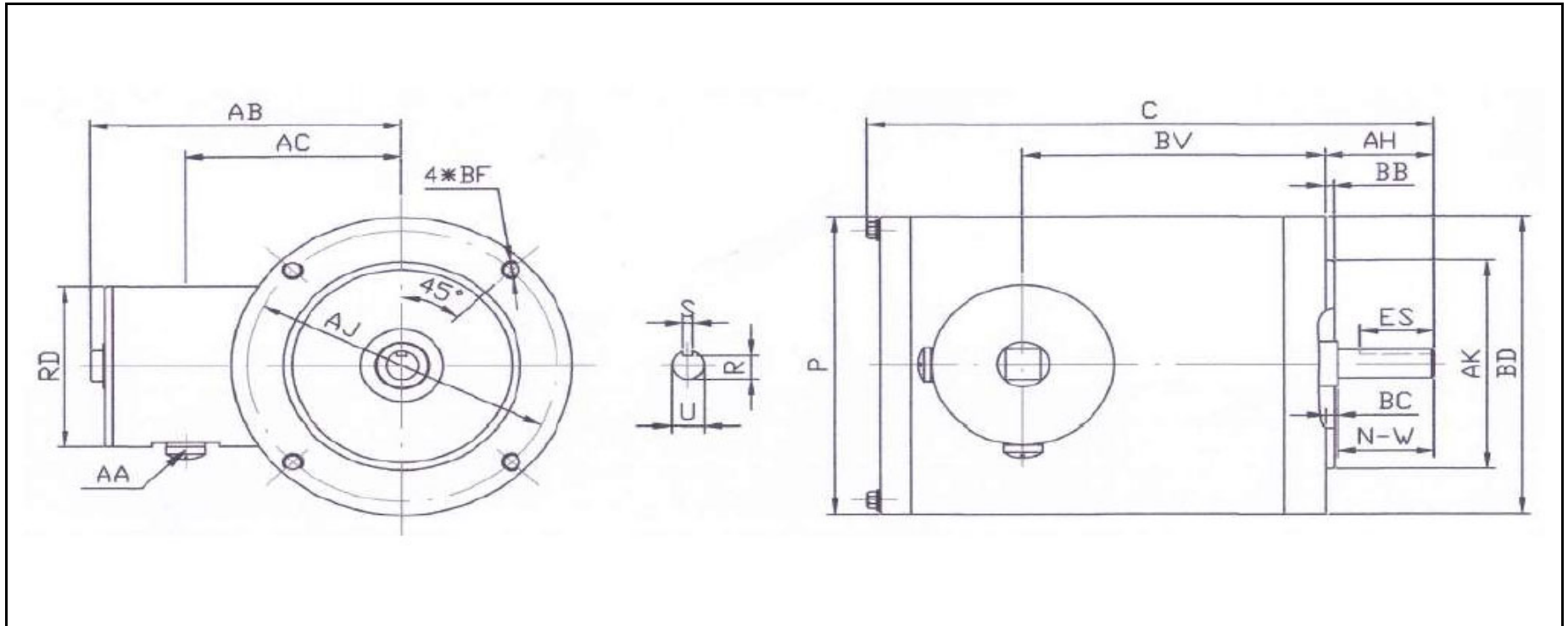

DIMENSIONS - INCHES

FLANGE MOUNTING						C	P	AB
AK	BD	AJ	BF	BB	BC			
4.5	6.45	5.875	(4) 3/8-16	0.16	0.12	12.02	6.45	5.95

SHAFT & KEY					
S	ES	R	N-W	U	AH
0.188	1.41	0.771	2.25	0.875	2.12

TERMINAL BOX			
AA	AC	RD	BV
1/2" NPT	4.5	3.45	6.95

PERFORMANCE CURVES

WorldWide Electric Corporation

1 (800) 808-2131

Worldwideelectric.net



Premium Efficiency Motor:

SSPENV1.5-36-143TRD

Document Generated: 15-Feb-2023	Customer:
Document ID:	

Motor Type	SSPE				
Output Rating (HP)	1.5	FL Speed	3525		
Full Load Torque	2.3 lb.ft	LRT (%FLT)	285	460 volt FLA	1.85
Rotor Wk ²	0.094 lb-ft ²	BDT (%FLT)	300	230 volt FLA	3.7

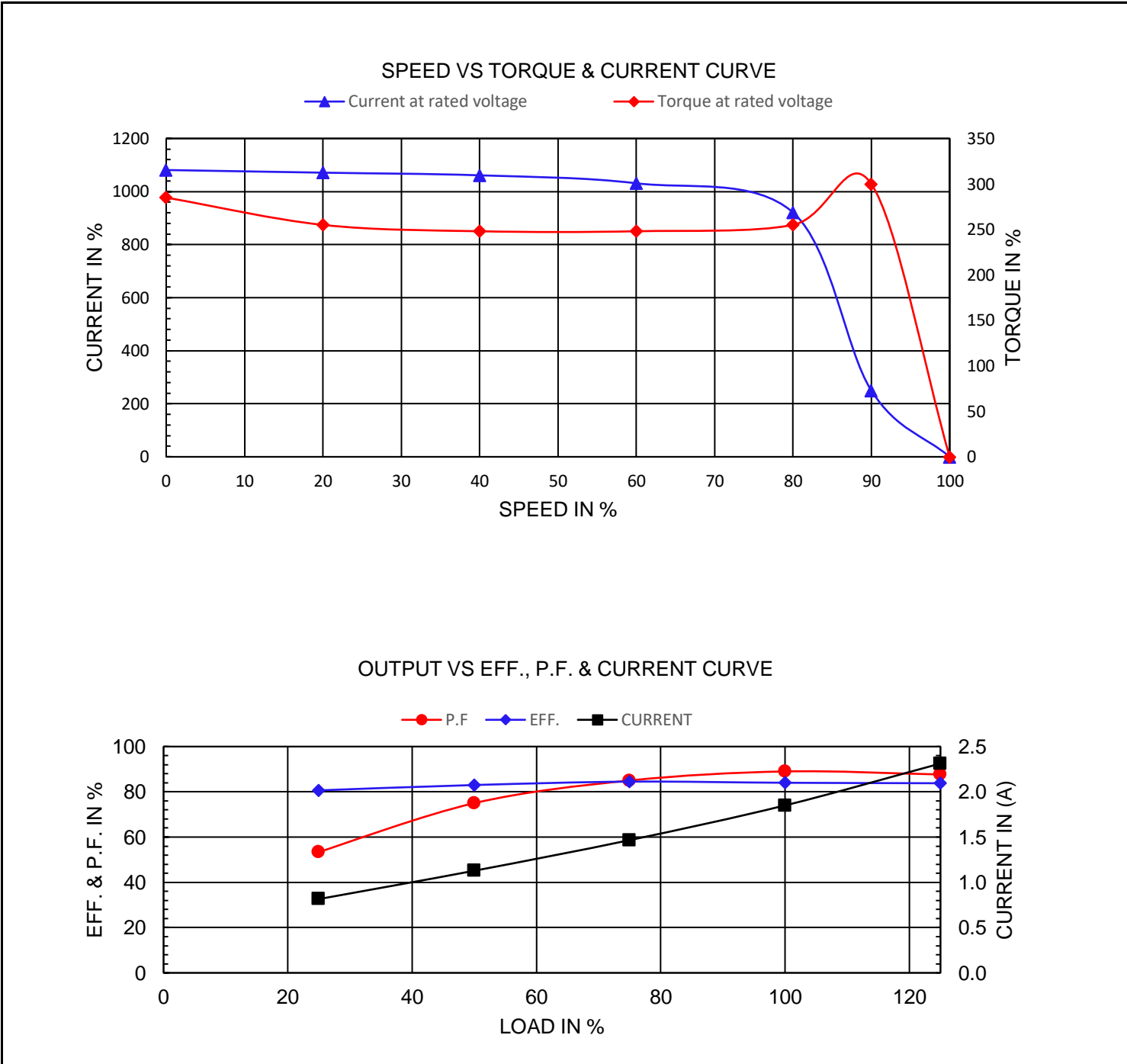

NAMEPLATE / WIRING

Premium Efficiency Motor:

SSPENV1.5-36-143TCRD

WorldWide Electric Corporation

1 (800) 808-2131





Worldwideelectric.net



Document Generated: 15-Feb-2023
Document ID:

Customer:

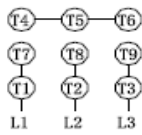
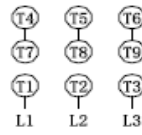
SAMPLE NAMEPLATE DATA

		THREE PHASE AC INDUCTION MOTOR INVERTER DUTY 20:1 VT 10:1 CT					
Model		FRAME		IP 69K	LB/WT		
Hz 60	S. F. 1.15	Hz 50	S. F. 1.15	ENCL. TEFC	AMB. 40°C		
HP	RPM	HP	RPM	DUTY CONT	INS. F		
VOLTS 230/460		VOLTS 190/380		NEMA DES. B			
AMP		AMP		BRG DE			
CODE	P. F.	CODE	P. F.	BRG ODE			
EFF	MIN	IE3 -		NO.			
							

Model	SSPENV1.5-36-143TCRD			FRAME	143TC	LB/WT	46 lbs.
Hz	60	S.F.	1.15	Hz	50	S.F.	1.15
HP	1.5	RPM	3525	HP	1	RPM	2910
VOLTS	230/460			VOLTS	190/380		
AMPS	3.7/1.85			AMPS	3.0/1.5		
CODE	M	P.F.	0.89	CODE	N	P.F.	0.92
EFF	84%	MIN	83%	IE3 -	80.7%		
BRG DE	6205 2RS						
BRG ODE	6205 2RS						