

DATA SHEET

Premium Efficiency Motor: **SSPENV13-36-56CRD,**

60 Hz

WorldWide Electric Corporation

1 (800) 808-2131

Worldwideelectric.net



Document Generated: 22-Feb-2023
Document ID:

Customer:

MOTOR INFORMATION	
HP	1/3
RPM	3600
Phase	3
Frequency	60
Voltage	230/460
Frame Size	56C
Enclosure	TENV
Degree of Protection	IP69K
Service Factor	1.15
Poles	2
Full Load Speed	3500
Insulation Class	F
Temp Rise	80°C
NEMA Code Letter	R
Duty Cycle	S1
Slip	2.78%
NEMA Design	B
Moment of Inertia	0.027 lb.ft.^2
Locked Rotor Time (Hot)	12 seconds
Sound Pressure Level	73 dB(A)
Number of Starts	12
Max Ambient Temperature	40° C
Max Elevation	1000 m.a.s.l (3300 f.a.s.l)
Mounting	F1
Rotation	Bidirectional
Area of Classification	Div.2 Class I, Gr. A,B,C&D T2B
Inverter Rating	10:1 CT/20:1 VT
Standard	NEMA MG1, UL1004
Approvals	CSA,UL,CE

EFFICIENCY/POWER FACTOR		
LOAD	EFF	P. F.
100%	72.0 %	0.78
75%	65.0 %	0.7
50%	55.0 %	0.6

TORQUE		
FULL LOAD	LRT	BDT
0.5 lb.ft.	290 %	320 %

AMPERAGE INFORMATION		
	230V	460V
Full Load Amps	1.1	0.55
Locked Rotor Amps	13	6.5
No Load Current	0.8	0.4
Usable at 208V		1

BEARING INFORMATION	
DE Bearing	6205 2RS
ODE Bearing	6205 2RS
Grease Type	Mobil Polyrex EM

ADDITIONAL DATA	
F2 Suitable	No
Shaft Material	304 Stainless Steel
Connection Diagram	9 Lead 2Y/Y
Approximate Weight	26 lbs.

WORLDWIDE ELECTRIC MOTOR DRAWING

SSPENV-56CRD (1/3, 1/2 HP)

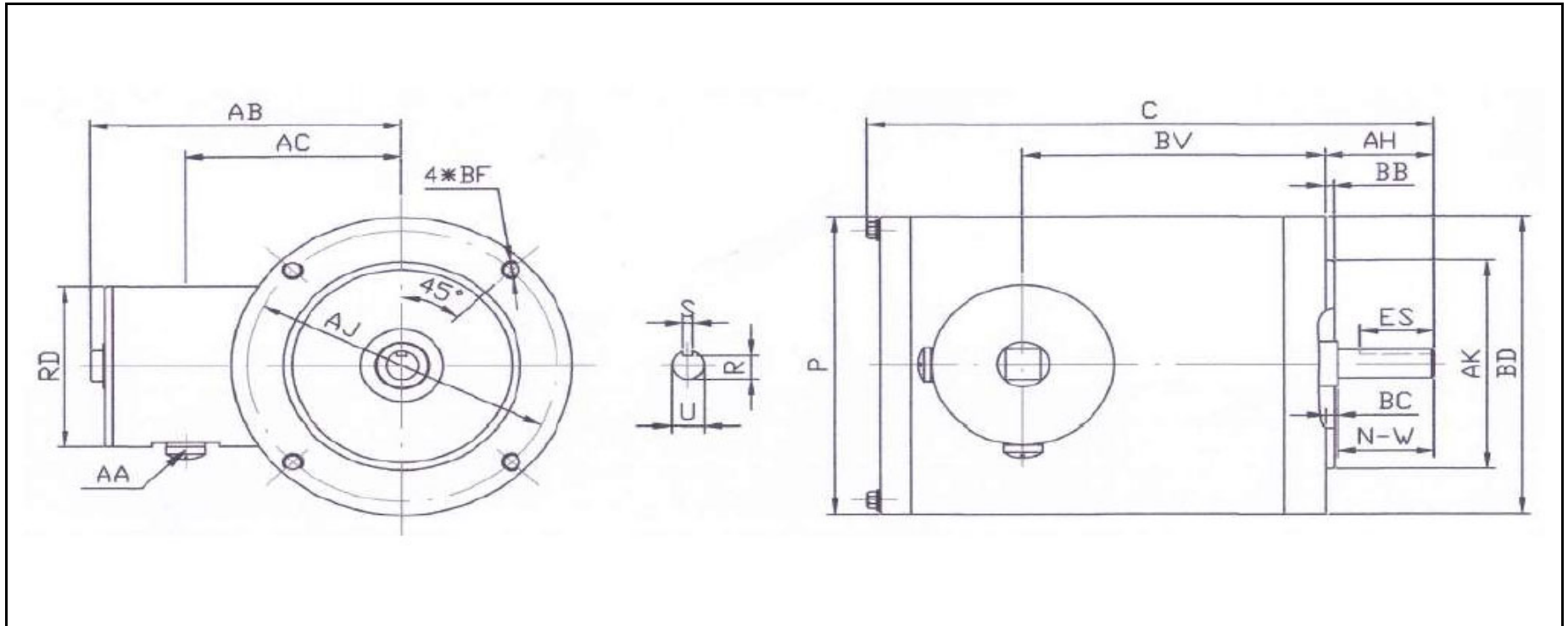

DIMENSIONS - INCHES

FLANGE MOUNTING						C	P	AB
AK	BD	AJ	BF	BB	BC			
4.5	6.45	5.875	(4) 3/8-16	0.16	-0.19	9.8	6.45	5.95

SHAFT & KEY					
S	ES	R	N-W	U	AH
0.188	1.41	0.517	1.88	0.625	2.06

TERMINAL BOX			
AA	AC	RD	BV
1/2" NPT	4.5	3.45	4.75

PERFORMANCE CURVES

WorldWide Electric Corporation

1 (800) 808-2131

Worldwideelectric.net



Premium Efficiency Motor:

SSPENV13-36-56CRD

Document Generated: 16-Feb-2023
Document ID:

Customer:

Motor Type	SSPE				
Output Rating (HP)	1/3	FL Speed	3500		
Full Load Torque	0.5 lb.ft	LRT (%FLT)	290	460 volt FLA	0.55
Rotor Wk ²	0.027 lb-ft ²	BDT (%FLT)	320	230 volt FLA	1.1

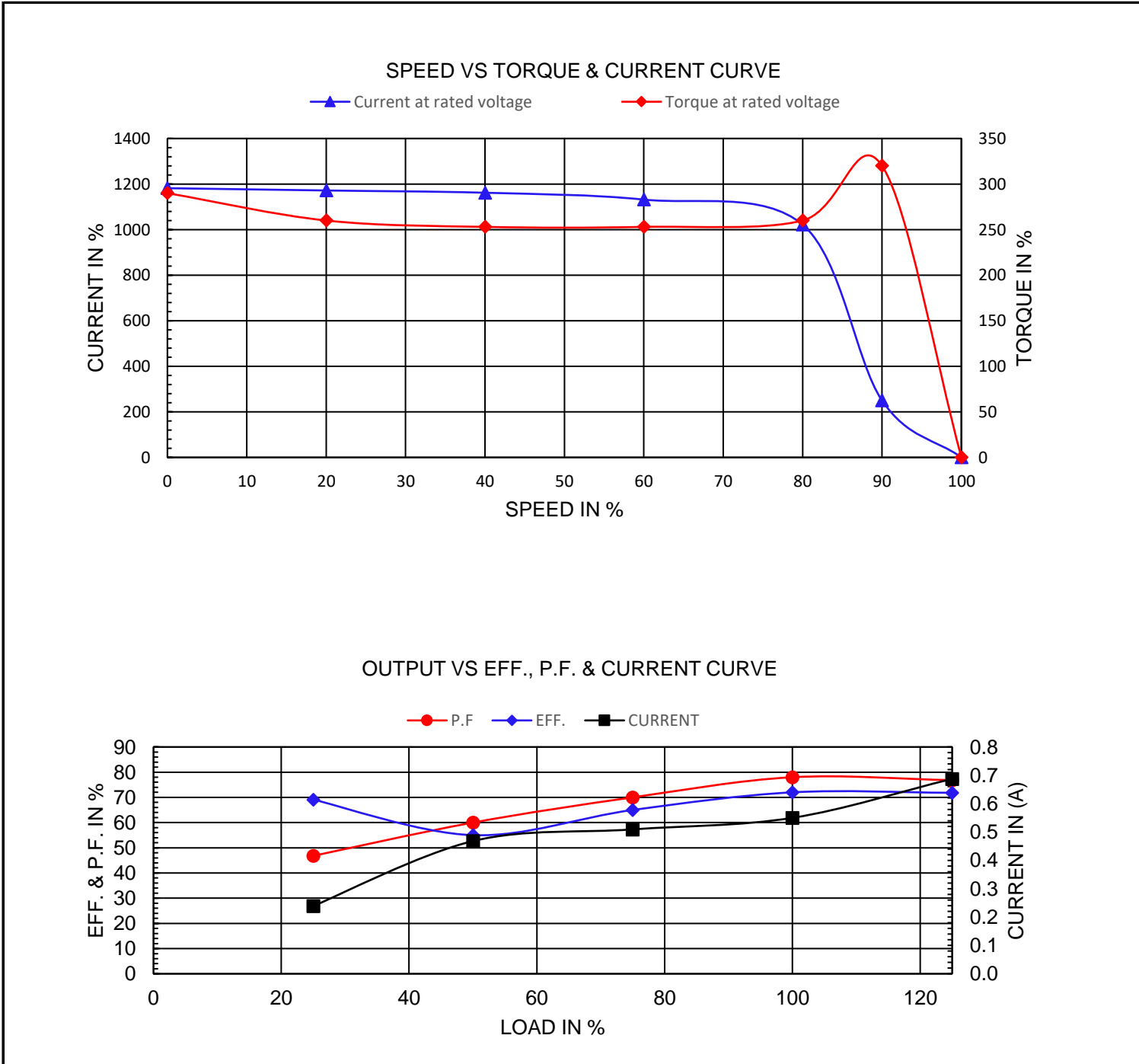

NAMEPLATE / WIRING

Premium Efficiency Motor:

SSPENV13-36-56CRD

WorldWide Electric Corporation

1 (800) 808-2131











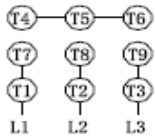

Worldwideelectric.net

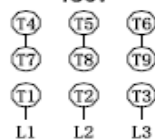

Document Generated: 16-Feb-2023
Document ID:

Customer:

SAMPLE NAMEPLATE DATA

		THREE PHASE AC INDUCTION MOTOR INVERTER DUTY 20:1 VT 10:1 CT							
Model .		FRAME		IP 69K	LB/WT		230V 		
Hz 60	S. F. 1.15	Hz 50	S. F. 1.15	ENCL. TEFC	AMB. 40°C				
HP	RPM	HP	RPM	DUTY CONT	INS. F				
VOLTS 230/460		VOLTS 190/380		NEMA DES. B			460V 		
AMP		AMP		BRG DE					
CODE	P. F.	CODE	P. F.	BRG ODE					
EFF	MIN	IE3 -		NO.					
									

Model	SSPENV13-36-56CRD			FRAME	56C	LB/WT	26 lbs.
Hz	60	S.F.	1.15	Hz	50	S.F.	1.15
HP	1/3	RPM	3500	HP	1/4	RPM	2890
VOLTS	230/460			VOLTS	190/380		
AMPS	1.1/0.55			AMPS	1.1/0.55		
CODE	R	P.F.	0.78	CODE	P	P.F.	0.76
EFF	72%	MIN	55%	IE3 -	65.9%		
BRG DE	6205 2RS						
BRG ODE	6205 2RS						