

DATA SHEET

Premium Efficiency Motor: **SSPENV3-18-182TC,**

60 Hz

WorldWide Electric Corporation

1 (800) 808-2131

Worldwideelectric.net



Document Generated: 22-Feb-2023
Document ID:

Customer:

MOTOR INFORMATION	
HP	3
RPM	1800
Phase	3
Frequency	60
Voltage	230/460
Frame Size	182TC
Enclosure	TENV
Degree of Protection	IP69K
Service Factor	1.15
Poles	4
Full Load Speed	1760
Insulation Class	F
Temp Rise	80°C
NEMA Code Letter	K
Duty Cycle	S1
Slip	2.22%
NEMA Design	B
Moment of Inertia	0.5 lb.ft.^2
Locked Rotor Time (Hot)	12 seconds
Sound Pressure Level	62 dB(A)
Number of Starts	12
Max Ambient Temperature	40° C
Max Elevation	1000 m.a.s.l (3300 f.a.s.l)
Mounting	F1
Rotation	Bidirectional
Area of Classification	Div.2 Class I, Gr. A,B,C&D T2B
Inverter Rating	10:1 CT/20:1 VT
Standard	NEMA MG1, UL1004
Approvals	CSA,UL,CE

EFFICIENCY/POWER FACTOR		
LOAD	EFF	P. F.
100%	89.5 %	0.82
75%	89.5 %	0.78
50%	88.0 %	0.67

TORQUE		
FULL LOAD	LRT	BDT
8.8 lb.ft.	240 %	300 %

AMPERAGE INFORMATION		
	230V	460V
Full Load Amps	7.6	3.8
Locked Rotor Amps	64	32
No Load Current	3.5	1.75
Usable at 208V		8

BEARING INFORMATION	
DE Bearing	6308 2RS
ODE Bearing	6306 2RS
Grease Type	Mobil Polyrex EM

ADDITIONAL DATA	
F2 Suitable	No
Shaft Material	304 Stainless Steel
Connection Diagram	9 Lead 2Y/Y
Approximate Weight	99 lbs.

SSPENV-182TC

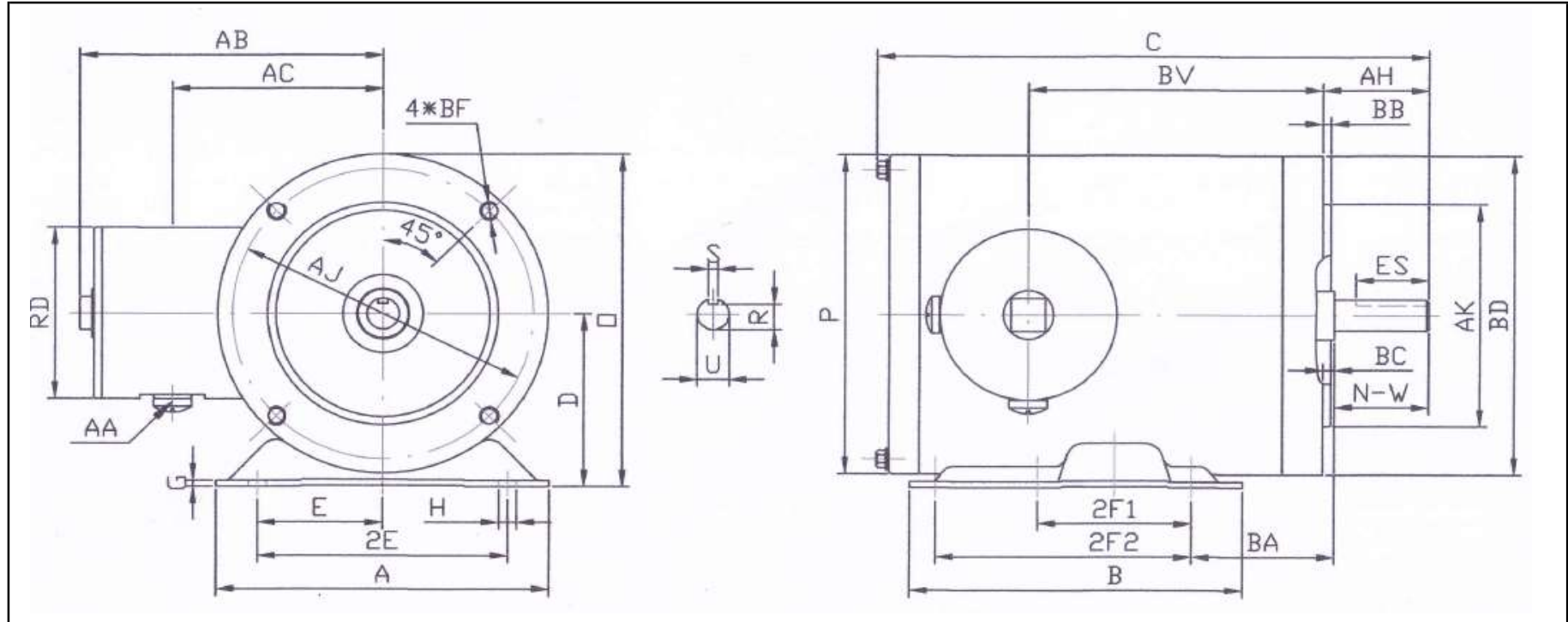

DIMENSIONS - INCHES

MOUNTING					A	B	C	D	G	T	P	O	BC	AB
E	2F1	2F2	H	BA										
3.75	4.5	5.5	0.71*0.47	3.5	8.8	6.5	14.70	4.5	0.118	1.45	8.58	9.55	0.12	7.00

SHAFT & KEY					
S	ES	R	N-W	U	AH
0.25	1.78	0.986	2.75	1.125	2.62

TERMINAL BOX				
AA	AB	AC	RD	BV
1/2	7	5.55	3.95	8.5

FLANGE				
AK	BD	AJ	BF	BB
8.5	8.85	7.25	(4*)/2-13	0.25

PERFORMANCE CURVES

Premium Efficiency Motor:

SSPENV3-18-182TC

WorldWide Electric Corporation

1 (800) 808-2131

Worldwideelectric.net



Document Generated: 30-Jan-2023
Document ID:

Customer:

Motor Type	SSPE		FL Speed	1760	
Output Rating (HP)	3		LRT (%FLT)	240	460 volt FLA 3.8
Full Load Torque	8.8	lb.ft	BDT (%FLT)	300	230 volt FLA 7.6
Rotor Wk^2	0.5	lb-ft^2			

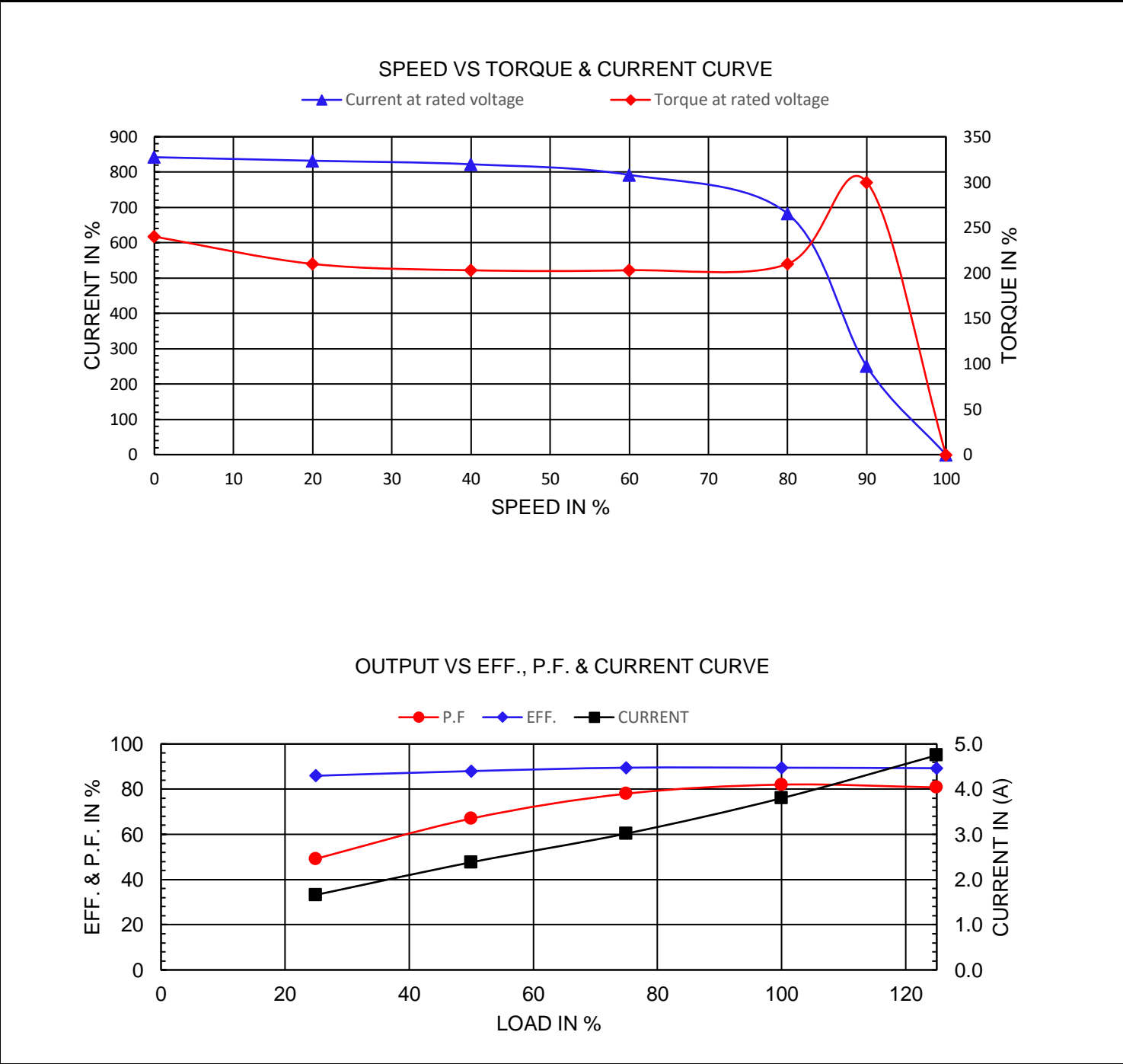

NAMEPLATE / WIRING

Premium Efficiency Motor: **SSPENV3-18-182TC**

WorldWide Electric Corporation

1 (800) 808-2131

Worldwideelectric.net



Document Generated: 30-Jan-2023	Customer:
Document ID:	

SAMPLE NAMEPLATE DATA

		THREE PHASE AC INDUCTION MOTOR INVERTER DUTY 20:1 VT 10:1 CT							
Model		FRAME		IP 69K	LB/WT				
Hz 60	S. F. 1.15	Hz 50	S. F. 1.15	ENCL. TEFC	AMB. 40°C				
HP	RPM	HP	RPM	DUTY CONT	INS. F				
VOLTS 230/460		VOLTS 190/380		NEMA DES. B					
AMP		AMP		BRG DE					
CODE	P. F.	CODE	P. F.	BRG ODE					
EFF	MIN	IE3 -		NO.					

Model	SSPENV3-18-182TC			FRAME	182TC	LB/WT	99 lbs.
Hz	60	S.F.	1.15	Hz	50	S.F.	1.15
HP	3	RPM	1760	HP	2	RPM	1455
VOLTS	230/460			VOLTS	190/380		
AMPS	7.6/3.8			AMPS	6.2/3.1		
CODE	K	P.F.	0.82	CODE	L	P.F.	0.84
EFF	89.5%	MIN	88%	IE3 -	85.3%		
BRG DE	6308 2RS						
BRG ODE	6306 2RS						