

DATA SHEET

WorldWide Electric Corporation

1 (800) 808-2131

Worldwideelectric.net



Premium Efficiency Motor: **WPMDC1-18-90V-56CB**

60 Hz

Document Generated: 3-Mar-2023

Document ID:

Customer:

MOTOR INFORMATION

HP	1
RPM	1800
Poles	4
Armature Voltage	90V
Frame Size	56C
Enclosure	TEFC
Degree of Protection	IP54
Armature Full Load Amps	10.4
Full Load Torque	2.92 lb.ft.
Form Factor	1.00
Service Factor	1.00
Insulation Class	F
Max Ambient Temperature	40°C
Base Type	C-Face with Removable Base
Duty Cycle	Continuous
Shaft	KEYED
DE Bearing	6203
ODE Bearing	6203
Mounting	F3
Rotation	Bi-Directional
Wire Type	Loose Wire
Wire Housing	Junction Box
Approximate Weight	32 lbs.
Full Load Efficiency	82.0 %
Standard	CSA-US

MOTOR DRAWING

Premium Efficiency Motor: **WPMDC1-18-90V-56CB**

WorldWide Electric Corporation

1 (800) 808-2131

Worldwideelectric.net

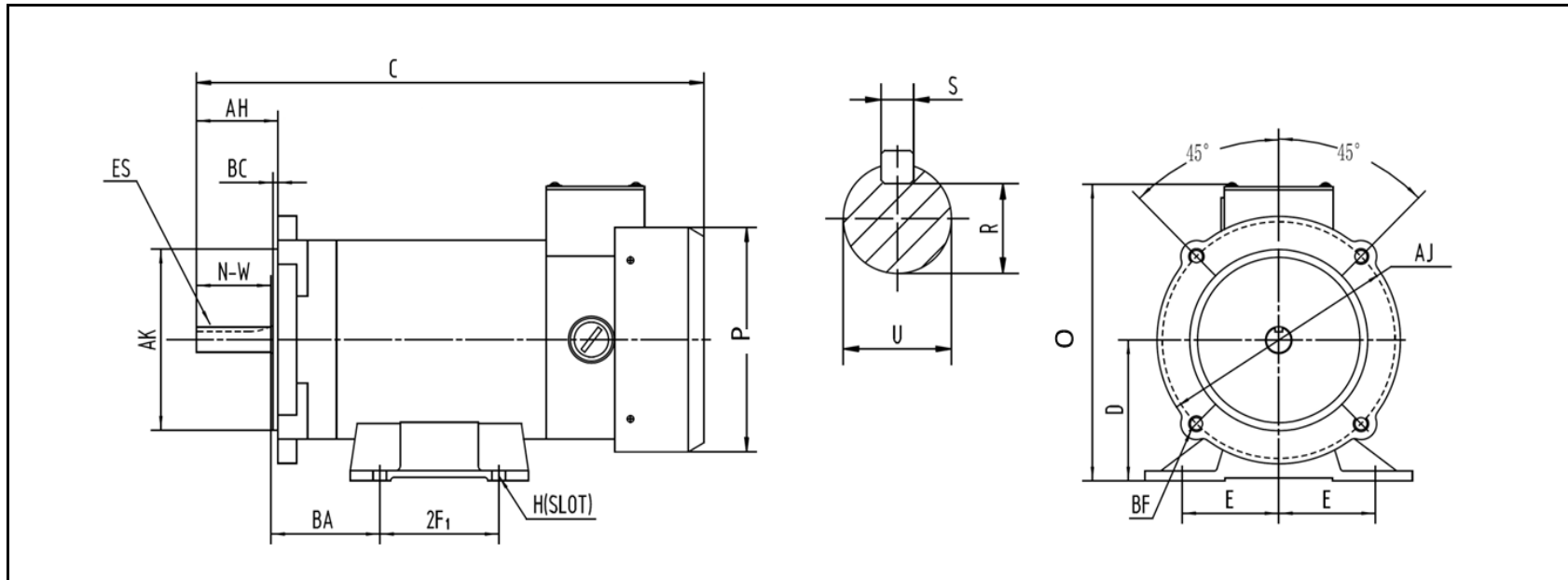

DIMENSION - INCHES

MOUNTING				C	D	O	P
E	2F1	H	BA				
2.44	3	0.34	2.75	14.3	3.5	7.63	5.57

SHAFT & KEY				
S	ES	R	N-W	U
0.188	1.41	0.517	1.88	0.625

FLANGE				
AK	AJ	BF	AH	BC
4.5	5.875	4*3/8-16	2.06	0.12